

DS-700AC

User's Manual



Copyright© 2021 silex technology, Inc. All rights reserved.

WA106490XB

Index

1. Introduction	1
1-1. Introduction	2
About the notation	2
Disclaimers.....	2
Trademarks	2
1-2. Safety Instructions	3
1-3. Notes on Use	6
1-4. Product Information and Customer Services	7
Product Information.....	7
Customer Support Center	7
2. About DS-700AC	9
2-1. Package Contents.....	10
2-2. Features.....	11
2-3. Specifications.....	14
2-3-1. Hardware Specifications	14
2-3-2. Software Specifications.....	18
2-4. About Wireless Interference	19
2-5. Parts and Functions	21
3. Before You Begin.....	25
3-1. Supported Configuration Methods	26
3-1-1. Configuration using a network cable (Recommended).....	26
3-1-2. Configuration using the WPS feature of your wireless router	27
3-1-3. Configuration using a USB flash drive	28
3-2. Necessary Wireless Setting Information.....	29
3-3. Setup Flow	31
3-3-1. Before You Begin	31
3-3-2. Setup Flow	31
3-3-3. Setup	32

3-3-4. Prepare other PCs to use DS-700AC	33
4. Software Overview	35
4-1. Necessary Utilities	36
4-1-1. What is Device Server Setup?	36
Setting TCP/IP	36
Wireless Setting	37
4-1-2. What is SX Virtual Link?	38
About SX Virtual Link	38
Functional Overview	39
4-2. Downloading the Utilities	40
5. Configuration	41
5-1. Configuration via a Network Cable (Recommended)	42
5-1-1. Necessary Items	42
5-1-2. Start Setup	43
Connect a network cable to and power on DS-700AC	43
Configure the network settings from your PC	44
5-1-3. Enable the new settings	50
5-2. Configuration via WPS	53
5-2-1. Confirm that your wireless router supports WPS	53
5-2-2. Prepare the necessary items	53
5-2-3. Start setup	54
5-3. Configuration via a USB Flash Drive	57
5-3-1. Necessary Items	57
5-3-2. Start Setup	58
Save the configuration information to a USB flash drive	58
Insert the USB flash drive into DS-700AC	63
Remove the USB flash drive from DS-700AC	64
6. Installing the Application to PC	67
6-1. Installing the Application in Windows	68

7. Using USB Devices Connected to DS-700AC 73

7-1. Using USB Devices in Windows	74
7-1-1. Starting SX Virtual Link.....	74
7-1-2. Connecting / Disconnecting to / from a USB device.....	75
7-1-3. Finishing SX Virtual Link.....	76
7-1-4. Online Help.....	77

8. Other Features 79

8-1. Using the Web Configuration Page.....	80
8-1-1. Displaying the Web page of DS-700AC.....	81
Using SX Virtual Link to display the Web page	81
Using a Web browser to display the Web page	83
8-1-2. Status Information	85
USB Device Status	85
System Status.....	86
UPnP Status	88
OpenVPN Status	89
Wireless Status.....	90
8-1-3. Network Settings.....	91
General Configuration.....	91
TCP/IP Configuration.....	92
NTP Configuration	95
UPnP Configuration.....	96
OpenVPN Configuration.....	97
Wired LAN Configuration	98
Wireless LAN Configuration.....	99
8-2. About the Print Server Feature.....	100
8-2-1. About the Print Server Feature.....	100
8-2-2. Before Using Standard Windows Printing.....	101
8-2-3. Printing Using the LPR Port on Windows 7	102
8-2-4. Printing Using the LPR Port on Windows 8/8.1/10 or Newer	105

8-2-5. Printing Using the Raw Port on Windows 7 or Newer	108
8-3. Wireless Configuration on Web Configuration Page	110
8-3-1. Easy Wireless Configuration	110
8-3-2. Detailed Wireless Configuration	112
8-3-3. IEEE802.1X Authentication	118
Supported 802.1X Authentication Methods	118
Standard and Saving Format for Certificate	118
IEEE 802.1X Settings	119
8-3-4. Smart Wireless Setup	123
PIN Code Method	124
8-4. Security Feature	127
8-4-1. USB Port Setting	127
8-4-2. Using Service Management Configuration	129
8-4-3. Filtering Accesses from a Particular PC.....	132
8-4-4. Server Certificate	135
8-4-5. Changing Root Password	138
8-5. Maintenance Feature	140
8-5-1. About ECO Mode.....	140
About ECO Mode.....	140
Turning on ECO Mode setting	140
Conditions to start ECO Mode	142
Conditions to finish ECO Mode	142
8-5-2. Resetting to Factory Defaults	143
Resetting using the push switch on DS-700AC.....	143
Resetting from the Web page.....	144
8-5-3. Rebooting DS-700AC.....	146
Manual reboot at the unit side.....	146
Remote reboot from the Web page.....	146
8-5-4. Updating Firmware.....	149
Downloading the latest firmware file	149
Updating the firmware.....	149
8-6. Using USB Devices over the Internet.....	152

8-6-1. Using USB Devices over the Internet	153
UPnP function setting	153
SX Virtual Link Setting	157
8-6-2. Deleting Port Forwarding Setting.....	159
8-6-3. Using OpenVPN Client Function.....	161
OpenVPN Client function setting	162
SX Virtual Link Setting	164
8-7. Using SX Virtual Link Lite	166
8-7-1. What is SX Virtual Link Lite?.....	166
Difference from SX Virtual Link.....	166
8-7-2. Installing SX Virtual Link Lite.....	167
8-7-3. SX Virtual Link Lite Setting	170
Using SX Virtual Link Lite	170
SX Virtual Link Lite Setting's Window.....	172
8-8. Uninstalling Application on Windows	174
8-8-1. Uninstalling SX Virtual Link.....	174
8-8-2. Uninstalling SX Virtual Link Lite	176
9. Troubleshooting	179
9-1. Useful Information	180
9-2. Q&A	183
9-2-1. Problems During Setup.....	183
9-2-2. Problems While Using DS-700AC	186

Blank page

1. Introduction

Thank you for purchasing the USB Device Server "DS-700AC".

This manual provides information on how to configure and use DS-700AC. Please read the **1-2. Safety Instructions** carefully before using DS-700AC.

1-1. Introduction

About the notation

This manual provides information on how to configure and use DS-700AC. Please read the Safety Instructions carefully before using DS-700AC.



: This symbol indicates important information that needs to be observed when operating DS-700AC. Make sure to read this information for safe and proper use.



Note

: This symbol indicates information that is useful when using DS-700AC. If you experience difficulties operating DS-700AC, please refer to this information first.

Disclaimers

- The unauthorized transfer or copying of the content of this manual, in whole or in part, without prior written consent expressly prohibited by law.
- The content of this manual is subject to change without notice.
- This manual was prepared to accurately match the content of each OS, but the actual information shown on the PC monitor may differ from the content of this manual due to future OS version upgrades, modifications, and other changes.
- Although every effort was made to prepare this manual with the utmost accuracy, Silex Technology will not be held liable for any damages as a result of errors, setting examples, or other content.

Trademarks



- AMC Manager is a registered trademark of Silex Technology.
- Microsoft, Windows, Microsoft Edge and Azure are either registered trademarks of Microsoft Corporation in the United States and/or other countries.
- Safari is registered trademark of Apple, Inc in the United States and/or other countries.
- Google Chrome is trademark of Google LLC.
- WPA, WPA2 and WPA3 are trademarks or registered trademarks of Wi-Fi Alliance.
- OpenVPN is a registered trademark of OpenVPN Inc.
- Other brand or product names are registered trademarks or trademarks of their respective owners.

1-2. Safety Instructions







This page provides the safety instructions for safe use of DS-700AC.

To ensure safe and proper use, please read the following information carefully before using DS-700AC. The safety instructions include important information on safe handling of DS-700AC and on general safety issues.

<Indication of the warning>





	Warning	"Warning" indicates the existence of a hazard that could result in death or serious injury if the safety instruction is not observed.
	Caution	"Caution" indicates the existence of a hazard that could result in serious injury or material damage if the safety instruction is not observed.

<Meaning of the symbols>

	This symbol indicates the warning and caution. (Example:  "Danger of the electric shock")
	This symbol indicates the prohibited actions. (Example:  "Disassembly is prohibited")
	This symbol indicates the actions users are required to observe. (Example:  "Remove the AC plug from an outlet")



Warning

	<ul style="list-style-type: none"> - In the following cases, turn off the connected devices and unplug the AC plug of this product from a power outlet. Failure to follow these instructions may cause fire or an electrical shock. <ul style="list-style-type: none"> - When this product emits a strange smell, smoke or sound or becomes too hot to touch. - When foreign objects (metal, liquid, etc.) gets into this product. - When this product is dropped or the case is broken or cracked.
	<ul style="list-style-type: none"> - Do not disassemble or modify this product. It may cause fire, electrical shock or malfunction. - Do not disassemble or modify the AC adaptor that came with this product. It may cause fire, electrical shock or malfunction.
	<ul style="list-style-type: none"> - Do not cover up the vents on this product. The temperature inside may rise and cause fire or malfunction. - Do not place any objects on top of this product. It may cause fire, electrical shock or malfunction. - Do not place any objects on top of this product. It may cause fire, electrical shock or malfunction. - Do not roll up or wrap the AC cord. It may cause fire or an electrical shock. - Do not plug or unplug the AC adaptor or any other cables with wet hands. It may cause an electrical shock or malfunction. - Keep the small parts out of reach of young children. If these are swallowed, consult a doctor immediately.
	<ul style="list-style-type: none"> - For use of the devices connected to this product, please follow all warnings, cautions and notices given by that manufacturer and carefully use them in a proper manner. - Failure to follow these instructions may cause fire, electrical shock or malfunction. - Use the correct power voltage. Improper voltage may cause fire or an electrical shock. - If a ground wire is supplied with your device to use with, connect it to the ground terminal in order to prevent an electrical shock. Do not connect the ground wire to gas pipe, water pipe, lighting rod or telephone ground wire. It may cause malfunction. - Keep the cords and cables away from children. It may cause an electrical shock or serious injury.



Caution

	<ul style="list-style-type: none"> - Use the AC adaptor supplied with this product. Other AC adaptors may cause malfunction. - Do not place any objects on the cable or bend, twist, or pull it excessively. - Do not use or store this product under the following conditions. - It may cause malfunction. <ul style="list-style-type: none"> - Locations subject to vibration or shock - Shaky, uneven or tilted surfaces - Locations exposed to direct sunlight - Humid or dusty places - Wet places (kitchen, bathroom, etc.) - Near a heater or stove - Locations subject to extreme changes in temperature - Near strong electromagnetic sources (magnet, radio, wireless device, etc.)
	<ul style="list-style-type: none"> - Do not pull on the cord to disconnect the plug from the power supply. The cord may be broken, which could result in fire or an electrical shock. - Follow the law of each country when you discard this product. - Verify all codes or cables are plugged correctly before using this product.
	<ul style="list-style-type: none"> - When this product will not be used for a long time, unplug the power cables of this product and the other devices you are using with it. - When removing this product, disconnect the AC plugs of both this product and the other devices you are using with it.

1-3. Notes on Use

This page explains the caution you need to pay attention to when using this product. Please be sure to read this page before begin.

- This product is not intended to be incorporated to or be used for control of equipment that affects human life or requires a high degree of reliability, such as medical equipment, nuclear equipment, aerospace equipment, and transportation equipment.
Silex Technology, Inc. is not liable for any injury, fire, property damage, etc. that may arise as a result of using this product for these facilities or control systems.
- Silex Technology, Inc. is not liable for any malfunction of the device connected to this product or loss, damage, falsification, leakage, etc. of the data of that device. The same applies when these problems occur as a result of unauthorized access to this product.
- When disposing of this product, please follow the regulations of your local governments.
- This product (and its accessories) is subject to change without a pre-notice.

1-4. Product Information and Customer Services

Product Information

The services below are available from the Silex Technology website. For details, please visit the Silex Technology website.

Silex Technology website
URL: <https://www.silextechnology.com/>

- Latest firmware download
- Latest software download
- Latest manual download
- Support information (FAQ)

Customer Support Center

Customer Support is available for any problems that you may encounter. If you cannot find the relevant problem in this manual or on our website, or if the corrective procedure does not resolve the problem, please contact Silex Technology Customer Support.

Contact Information	
USA	support@silexamerica.com
Europe	support@silexeurope.com



Note

- Refer to the Silex Technology website (<https://www.silextechnology.com/>) for the latest FAQ and product information.

Blank page

2. About DS-700AC

2-1. Package Contents

This page explains the items that came with DS-700AC.

Following items are bundled with DS-700AC.

If you find any items missing, please contact your point of purchase.

- DS-700AC
- AC adaptor
- Setup Guide
- Distribution of source code subject to open source software

2-2. Features

This page explains the Features of DS-700AC.

IEEE802.11a / b / g / n / ac for wireless LAN standard

As DS-700AC supports IEEE802.11a/b/g/n/ac, various USB devices can be shared over a wireless network. The following authentication and encryption methods are supported.

Authentication method	Encryption mode
Open	None
	WEP
WPA2-Personal	AES
WPA3-Personal	AES
WPA/WPA2-Personal	AUTO
WPA2-Enterprise	AES
WPA3-Enterprise	AES
WPA/WPA2-Enterprise	AUTO

Supports Gigabit Ethernet

High-speed data transfer with Gigabit Ethernet (1000BASE-T) as well as 100BASE-TX/10BASE-T Ethernet (auto-sensing).

Easy Configuration

If a DHCP server (or broadband router with DHCP function) is installed to your network, you can use the DS-700AC just by connecting it to the network.

Also, when you want to assign IP address to your network devices manually, you can easily configure the DS-700AC using the Device Server Setup which can be downloaded from our website.

Wireless Configuration Using a Push Switch

DS-700AC support the wireless configuration using Smart Wireless Setup. If your wireless router (Access Point) supports WPS (Wi-Fi Protected Setup), you can configure the wireless settings easily using the push switch.

USB Device Server Feature

- Share various USB devices

By using DS-700AC and the bundled utility, SX Virtual Link, you can share various USB devices such as printers, scanners and storage devices among Windows PC (refer to **2-3-2. Software Specifications**). DS-700AC allows you to use USB devices as if they were connected directly to your PC.

(For details on SX Virtual Link, refer to **4-1-2. What is SX Virtual Link?**)

- Support USB device that uses isochronous transfer

You can share the USB devices that use isochronous transfer (e.g. Web camera, USB speaker, etc) over the network. For the isochronous devices, it is recommended to use Gigabit Ethernet environment.

- Printer auto connection

When printing to a USB device, the print operation executed to the device will automatically prompt SX Virtual Link to connect with the device to print and disconnect after the job is printed. It is not required to manually connect to the device with SX Virtual Link for printing.



- Silex Technology shall not be liable for any loss or damage of data in data storage devices resulting from the use of DS-700AC. Silex Technology shall also not be liable for any leak, manipulation, loss, or corruption of data in data storage devices connected to DS-700AC as a result of improper use.
- If a USB HUB is used, multiple USB devices can be connected, however, the USB3.0 port does not support connection of a USB HUB. Also, when using a USB HUB for the USB2.0 port, make sure that only one HUB is connected.
- When you use isochronous devices such as Web camera, USB speaker, etc, please connect them directly to DS-700AC.
- If isochronous devices such as Web cameras or USB speakers, etc. are used on a 100BASE-TX/10BASE-T network, frame dropping or sound skipping may occur.
- Some USB devices may not be supported depending on the driver specification. For the latest compatibility information, please visit our website (<https://www.silextechnology.com/>).

Print Server Feature

- Supports Raw/LPR printing

DS-700AC supports "Raw" and "LPR" of network printing protocols.

When a printer is connected to DS-700AC, you can use the standard Windows printing feature. Print server feature runs in bidirectional communication.



- Depending on the USB printing device specification, the Printer auto connection function may not be available.
- When a print server feature is used, it is impossible to get printer status using the status monitor software that came with the printer or MFP.
Also, if the printer supports bi-directional printing only, a print server feature cannot be used.
- When using a print server feature, only 1 printer can be used at a time. To connect 2 or more printers, SX Virtual Link must be used.
- Some USB devices may not be supported depending on the driver specification. For the latest compatibility information, please visit our website (<https://www.silextechnology.com/>).

ECO Mode

If DS-700AC is not used for a specified period of time, it will switch to ECO Mode which turns off the USB Bus power. This feature allows you to save power used by USB Bus powered devices connected to DS-700AC. As soon as DS-700AC is used during ECO Mode, the USB Bus power will automatically be switched on again.

Please note that DS-700AC will not switch to ECO Mode if the USB device connection utility, "SX Virtual Link", is active on any PCs in your network. Please shut down all PCs that have SX Virtual Link installed or close SX Virtual Link on each PC to use this feature.

Supports "AMC Manager® "(non-free program / free program)

The AMC Manager® provides the useful features as follows:

- Remote device control and monitoring
- Bulk configuration and firmware updates



- For details on the "AMC Manager®", please visit our homepage.

Note

2-3. Specifications

2-3-1. Hardware Specifications

This page explains the hardware specification of DS-700AC.

Memory	SDRAM	256MByte	
	FlashROM	32MByte	
Device interface	USB 2.0 Hi-Speed (A Type) x 1 port USB 3.0 Super-Speed (A Type) x 1 port		
Push Switch	1 button		
LINK LED	LAN Port	2	LINK (Green / Orange)
			POWER (Yellow)
	TOP	3	POWER (Green)
			WLAN (Orange / Green)
			SETTING (Red / Green)
Network interface	RJ-45 x 1port 10BASE-T / 100BASE-TX / 1000BASE-T (Auto-sensing)		
Wireless network interface	IEEE802.11a/b/g/n/ac		
Channel	(US/CA) 2.4GHz: 1-11ch 5GHz: (W52) 36,40,44,48ch (W53) 52,56,60,64ch (W56) 100,104,108,112,116,132,136,140,144ch (W58) 149,153,157,161,165ch (EU/UK) 2.4GHz: 1-13ch 5GHz: (W52) 36,40,44,48ch (W53) 52,56,60,64ch (W56) 100,104,108,112,116,120,124,128,132,136,140ch		

Power supply	AC100V adaptor, DC 12V	
Maximum power consumption	5.4W (excluding USB bus power)	
	Temperature	0°C to +40°C / +32°F to +104°F
	Humidity	20% to 80%RH (Non-condensing)
Storage environment	Temperature	-10°C to +50°C / +14°F to +122°F
	Humidity	20% to 90%RH (Non-condensing)
EMI	VCCI Class B FCC Class B ICES Class B CE / UKCA Class B	

Notice to US Customers



Contains FCC ID: N6C-SXPCEAC2

This device complies with Part 15 of the FCC Rules. Operation is subject to the following two conditions: (1) This device may not cause harmful interference, and (2) this device must accept any interference received, including interference that may cause undesired operation.

FCC CAUTION

Changes or modifications not expressly approved by the party responsible for compliance could void the user's authority to operate the equipment.

FCC Rules Part 15 Subpart B

Note: This equipment has been tested and found to comply with the limits for a Class B digital device, pursuant to part 15 of the FCC Rules. These limits are designed to provide reasonable protection against harmful interference in a residential installation. This equipment generates, uses and can radiate radio frequency energy and, if not installed and used in accordance with the instructions, may cause harmful interference to radio communications. However, there is no guarantee that interference will not occur in a particular installation. If this equipment does cause harmful interference to radio or television reception, which can be determined by turning the equipment off and on, the user is encouraged to try to correct the interference by one or more of the following measures:

- Reorient or relocate the receiving antenna.
- Increase the separation between the equipment and receiver.
- Connect the equipment into an outlet on a circuit different from that to which the receiver is connected.
- Consult the dealer or an experienced radio/TV technician for help.

Co-Location Rule

This transmitter must not be co-located or operated in conjunction with any other antenna or transmitter.

Frequency Tolerance: +/-20 ppm

Notice to Canadian Customers

CAN ICES-3 (B)/NMB-3 (B)

This device contains licence-exempt transmitter(s)/receiver(s) that comply with Innovation, Science and Economic Development Canada’s licence-exempt RSS(s). Operation is subject to the following two conditions:

1. This device may not cause interference.
2. This device must accept any interference, including interference that may cause undesired operation of the device.

L'émetteur/récepteur exempt de licence contenu dans le présent appareil est conforme aux CNR d'Innovation, Sciences et Développement économique Canada applicables aux appareils radio exempts de licence. L'exploitation est autorisée aux deux conditions suivantes :

1. L'appareil ne doit pas produire de brouillage;
2. L'appareil doit accepter tout brouillage radioélectrique subi, même si le brouillage est susceptible d'en compromettre le fonctionnement.

for indoor use only

Pour usage intérieur seulement

Notice to European Customers

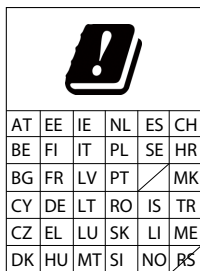

Notice to UK Customers



Restrictions or Requirements in the UK

2-3-2. Software Specifications

This page explains the software specification of DS-700AC.

Supported protocols	ARP, ICMP/ICMPv6, IP/IPv6, TCP, UDP, DHCP/DHCPv6, HTTP/HTTPS, NBNS, LLMNR, mDNS, DNS, SNTP, SNMPv1, JCP(silex proprietary protocol), SXUPTP(silex proprietary protocol), SX-KeepAlive(silex proprietary protocol), TCP#9100, LPD, SXSMP(silex proprietary protocol)
Supported OS	Windows 7 or later Windows Server 2008R2 or later
Number of max connection at a time	15 (Only one printer can be connected using Raw Port, LPD printings.)



- For the latest compatibility information for each operating system, visit our website (<https://www.silextechnology.com/>).



Note

About USB Hub connection

The USB3.0 port of DS-700AC does not support connection with a USB HUB, USB HUB embedded device and USB video converter.

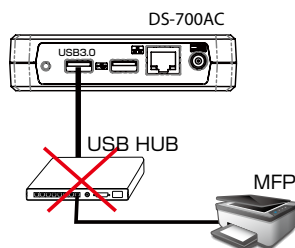

About the number of connection

If DS-700AC is used with a MFP as shown below, total 3 connections will be occupied (1 connection for each printer, scanner and storage features).

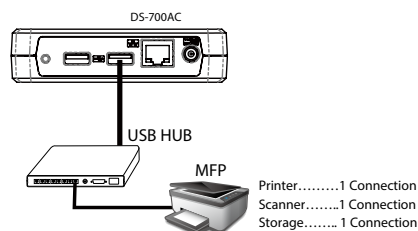

2-4. About Wireless Interference

This page explains the radio wave used by DS-700AC.

DS-700AC operates at 2.4GHz and 5GHz bands.

No radio license is required to use DS-700AC, however, please give attention of the followings:

Do not use DS-700AC near the following devices or places.

The following devices may use the same band. If you use DS-700AC near these devices, the radio waves emitted from DS-700AC and the following devices may interfere with each other.

- Microwave, scientific instruments, pacemaker or other medical equipment, etc.
- Licensed radio station in a factory
- Small power radio station (A non-licensed radio station)

Do not use DS-700AC near a cellular phone, TV or Radio.

A cellular phone, TV and radio use a different radio band than our products. Generally, if they are used near DS-700AC, it will not cause any problems. However, when they approximate DS-700AC, sound or image noise may occur.

If there is reinforced concrete/metal between wireless devices, they may not connect.

DS-700AC can connect through wood or glass, but may have troubles connecting through reinforced concrete/metal.

Wireless devices using 2.4GHz band

The same frequency band of DS-700AC is used for a microwave, industry, science, medical equipment and licensed in room or low power (non-licensed) radio stations.

- Before you use DS-700AC, check that it will not interfere with other devices.
- If interference occurs, stop using DS-700AC or change the wireless band. Please consider to create a wall between these devices to avoid interference. Contact us to for possible solution.



2.4	Shows the frequency of the device is 2.4GHz.
DS/OF	Shows the used modulation is DS-SS and OFDM.
4	Shows the range of interference is (≤ 40 m).
	Shows that different channels can be used to avoid interference.

Notes on using 5GHz band

Use of 5.2GHz band (W52) and 5.3GHz band (W53) outdoors is prohibited by the radio law. Be sure to use only W56 channel and not to use W52/W53 channels outdoors.

2-5. Parts and Functions

This page explains the parts and functions of DS-700AC.

The parts name and functions are as follows:

<TOP>

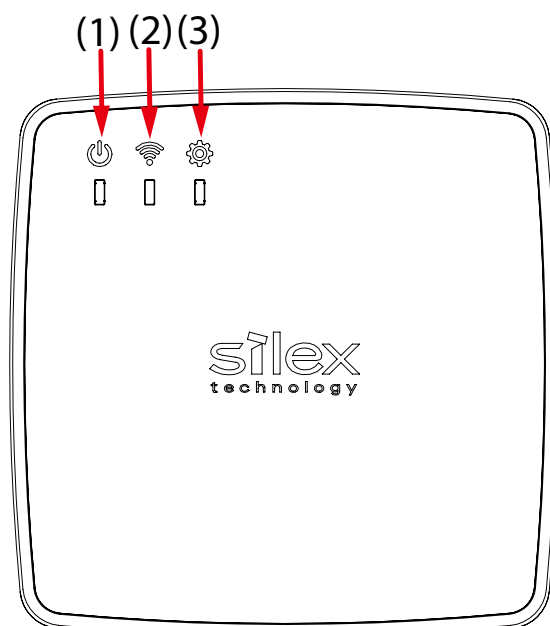

(1)	POWER LED	ON (Green)	Turns on when DS-700AC is powered on.
(2)	WLAN LED	Blink (Orange)	Searching for Access Points (blinks at 1 sec interval).
		ON (Green)	Has connected to Access Point in Infrastructure mode.
		Blink (Green)	Receiving packets over wireless LAN.
		OFF	Operating in a wired LAN mode.
(3)	SETTING LED	Blink (Green)	Smart Wireless Setup is in progress.
		Blink (Red)	Smart Wireless Setup error

<FRONT>

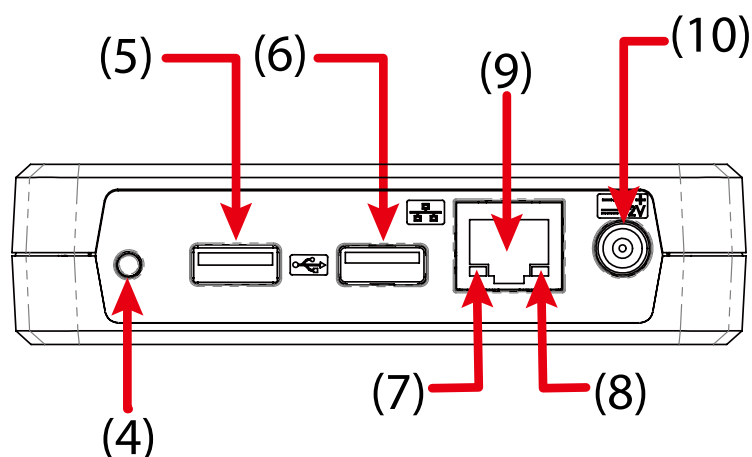

(4)	Push Switch	Resets DS-700AC to the factory default settings. For details, refer to 8-5-2. Resetting to Factory Defaults . Also, this switch can be used to configure the wireless settings. For details, refer to 5-2. Configuration via WPS .	
(5)	USB3.0 Port	Connect a USB3.0 device. (USB3.0 Super-Speed)	
(6)	USB2.0 Port	Connect a USB2.0 device. (USB2.0 Hi-Speed)	
(7)	LINK LED	ON (Green)	Indicates a network port status. 1000BASE-T:ON
		ON (Orange)	Indicates a network port status. 10BASE-T:ON / 100BASE-TX:ON
(8)	POWER LED	ON (Yellow)	Lights up when DS-700AC is powered on.
(9)	Network Port	Connect a network cable. 10BASE-T / 100BASE-TX / 1000BASE-T (Auto-sensing)	
(10)	Power Connector	Connect an AC adaptor.	

**TIP**

- If an overcurrent is detected on a USB port, power supply to the USB port is automatically cut off via an overcurrent protection feature.
- If you are using USB devices that run on USB Bus power, it is recommended to avoid using two or more devices at once, so that the total power used does not exceed the maximum power capability of DS-700AC.

<BOTTOM>

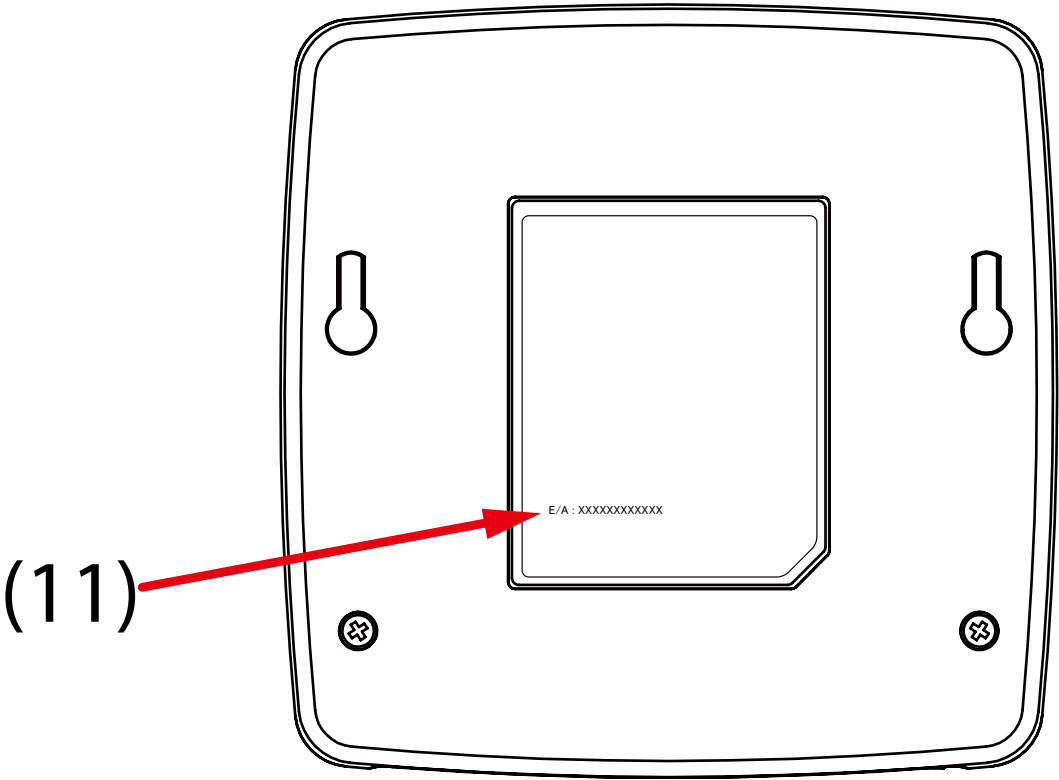

(11)	MAC Address	MAC Address of DS-700AC. Example) If the MAC Address is 84:25:3F:00:11:22, it is noted as "84253F001122".
------	-------------	--

Blank page

3. Before You Begin

This page introduces the supported configuration methods for DS-700AC.

3-1. Supported Configuration Methods

About configuration methods

The following 3 configuration methods are supported.
Please select the one appropriate for your environment.

3-1-1. Configuration using a network cable (Recommended)

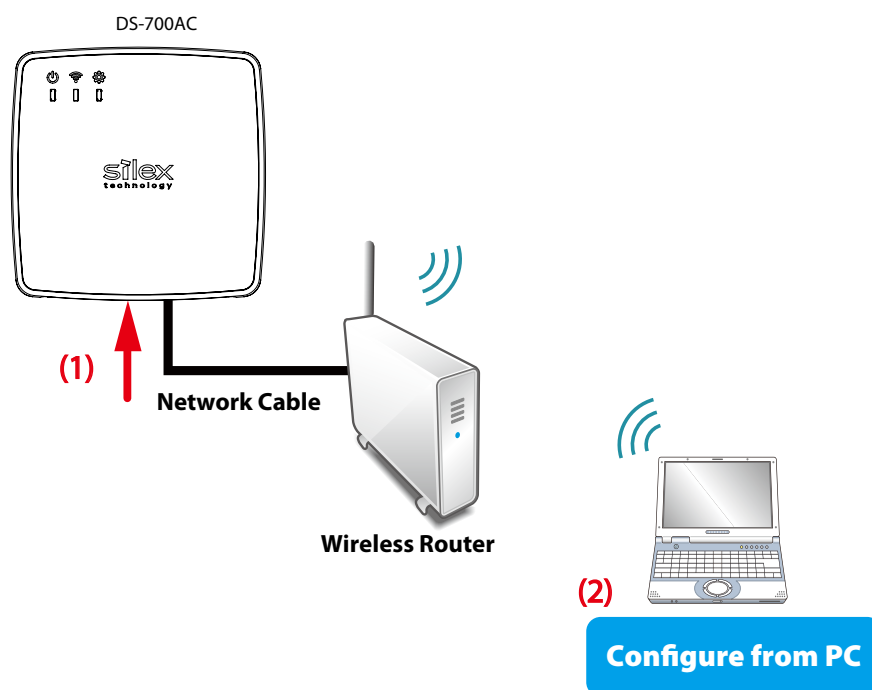

By connecting DS-700AC to your existing network using a network cable, you can configure the network settings from your PC using the configuration utility that you downloaded from our website. For this method, a network cable is required.

If you plan to use DS-700AC in a wireless network, please obtain your wireless setting information beforehand. The network cable is used only for setup. Unplug the cable when you finish the setup.

If you plan to use DS-700AC in a wired network, you do not have to obtain the wireless setting information. Also, the network cable does not need to be unplugged.

3-1-2. Configuration using the WPS feature of your wireless router

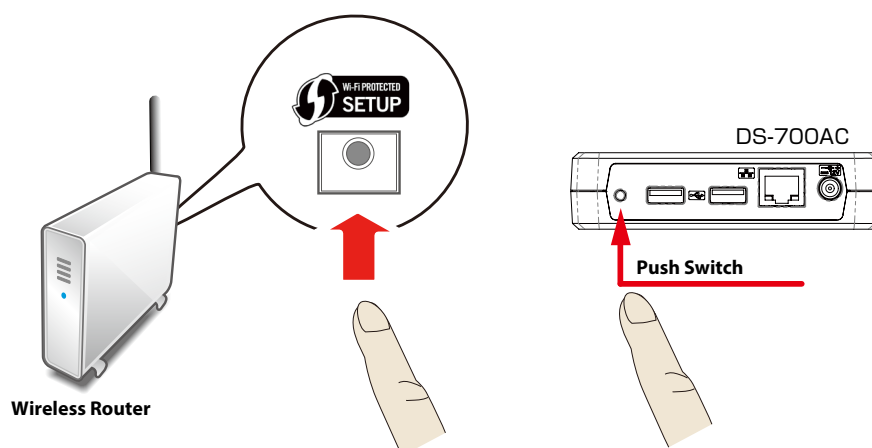

If your wireless router supports WPS (Wi-Fi Protected Setup), the network configuration can be done automatically by pressing the wireless connection button on your router and the push switch on DS-700AC.

For this configuration method, a wireless router supporting WPS is required. To see if your router supports WPS, refer to the operation manual that came with your router or contact the manufacturer.

You do not need to obtain any wireless setting information beforehand, since the wireless settings are automatically configured between DS-700AC and your router.

3-1-3. Configuration using a USB flash drive

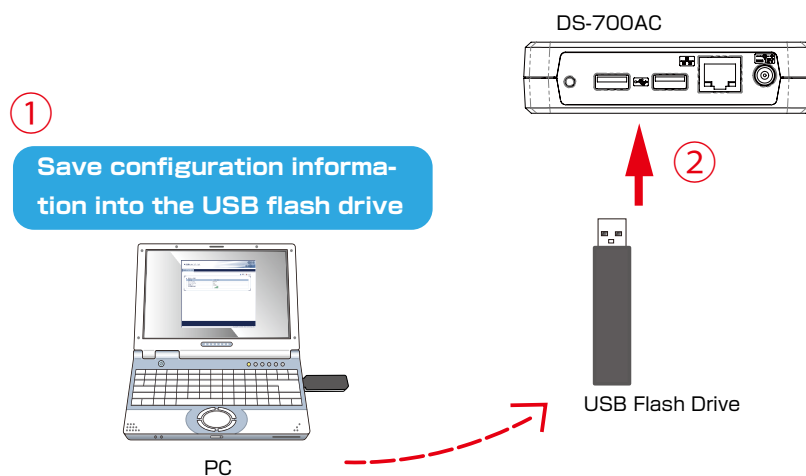

By saving the configuration information to a USB flash drive and connecting it to DS-700AC, you can configure the network settings. For this configuration method, a USB flash drive is required. Only a few KB of free memory is required on the USB flash drive and it is OK if there are other files present on it.

To save the configuration information to the USB flash drive, please use the configuration utility that you downloaded from our website.

If you plan to use DS-700AC on a wireless network, please obtain your wireless setting information beforehand.

**Note**

- If you have access to the Web configuration page of DS-700AC, you can also configure the wireless settings from there.

For details on how to configure the settings from the Web configuration page, refer to **8-1-1. Displaying the Web page of DS-700AC.**

3-2. Necessary Wireless Setting Information

This page explains the wireless setting information that you need to obtain before starting the setup.

**Note**

- In the following cases, you do not have to obtain the information detailed on this page:
 - If you plan to use DS-700AC in a wired network
 - If you plan to configure DS-700AC using the WPS feature of your wireless router

To use DS-700AC in your wireless network, DS-700AC must have the same settings as your wireless router (Access Point).

**TIP**

- The information explained in this page is specific to your network and cannot be provided by Silex technical support. For how to confirm each setting, please refer to the operation manual that came with your router or contact the manufacturer.
- Depending on your wireless router, WPS may need to be enabled manually. For details, refer to the operation manual that came with your wireless router.
- If a security feature such as MAC Address filtering is enabled on your wireless router, disable it temporarily so that DS-700AC can communicate with your wireless router. For details, refer to the operation manual that came with your wireless router.

Check the wireless setting information of your wireless router as follows:

SSID	<p>The SSID is an ID that distinguishes a wireless LAN network from others. For wireless devices to communicate with each other on a wireless network, they must share the same SSID. (The SSID is also referred to as "ESSID".) Depending on your wireless router, it may have several SSIDs. If there are different SSIDs for a game console and PC, use the one for the PC.</p>															
Encryption Mode	No Encryption	<p>Uses no encryption for wireless communication. (In this case, you do not have to get any of your settings beforehand.)</p>														
	WEP	<p>If WEP encryption is used, wireless communication will be encrypted using the settings for "WEP Key 1-4" and "Key Index". Set the same "WEP Key Size(64bit/128bit)", "WEP Key" and "Key Index" as your wireless router.</p> <p>There are "Hexadecimal" and "Alphanumeric" to input the WEP key. In most cases, alphanumeric characters are used. Enter 5 characters if the key size is 64bit or 13 characters if the key size is 128bit.</p> <p>For Hexadecimal, a value consists of numbers (0-9) and English letters (A-F). Enter a 10-digit value if the key size is 64bit or a 26-digit value if the key size is 128bit.</p> <table border="1" style="margin-left: auto; margin-right: auto;"> <thead> <tr> <th colspan="3" style="text-align: center;">WEP Key Length</th> </tr> <tr> <th rowspan="2"></th> <th colspan="2" style="text-align: center;">WEP Key Size</th> </tr> <tr> <th style="text-align: center;">64bit</th> <th style="text-align: center;">128bit</th> </tr> </thead> <tbody> <tr> <td style="text-align: center;">Hexadecimal</td> <td style="text-align: center;">10 (digit) characters</td> <td style="text-align: center;">26 (digit) characters</td> </tr> <tr> <td style="text-align: center;">Alphanumeric</td> <td style="text-align: center;">5 characters</td> <td style="text-align: center;">13 characters</td> </tr> </tbody> </table>	WEP Key Length				WEP Key Size		64bit	128bit	Hexadecimal	10 (digit) characters	26 (digit) characters	Alphanumeric	5 characters	13 characters
	WEP Key Length															
	WEP Key Size															
	64bit	128bit														
Hexadecimal	10 (digit) characters	26 (digit) characters														
Alphanumeric	5 characters	13 characters														
WPA / WPA2 / WPA3	<p>Uses PSK for network authentication. The encryption key will be generated by communicating with the wireless router using a Pre-Shared key. WEP key setting is not used for this mode. Set the same "Pre-Shared key" and "Encryption Mode" (AUTO/AES*) as your wireless router. (The Pre-Shared key is also referred to as "Network Key" or "Password".) * For WPA2/WPA3, only AES is supported.</p> <p>For the Pre-Shared Key, 8-63 alphanumeric characters or 64 hexadecimal value (numbers 0-9 and letters A-F) can be used. WPA3-AES does not support 64 hexadecimal characters.</p>															

3-3. Setup Flow

3-3-1. Before You Begin

1. Install a USB device driver to your PC

Install a driver of the USB device to be shared using DS-700AC to your PC.

For details on how to install the driver, please refer to the operation manual that came with the USB device.

2. Collect your wireless setting information

To use DS-700AC in your wireless network, DS-700AC must have the same settings as your wireless router.

For details, refer to **3-2. Necessary Wireless Setting Information**.

3-3-2. Setup Flow

Follow the procedures below to install and setup DS-700AC.

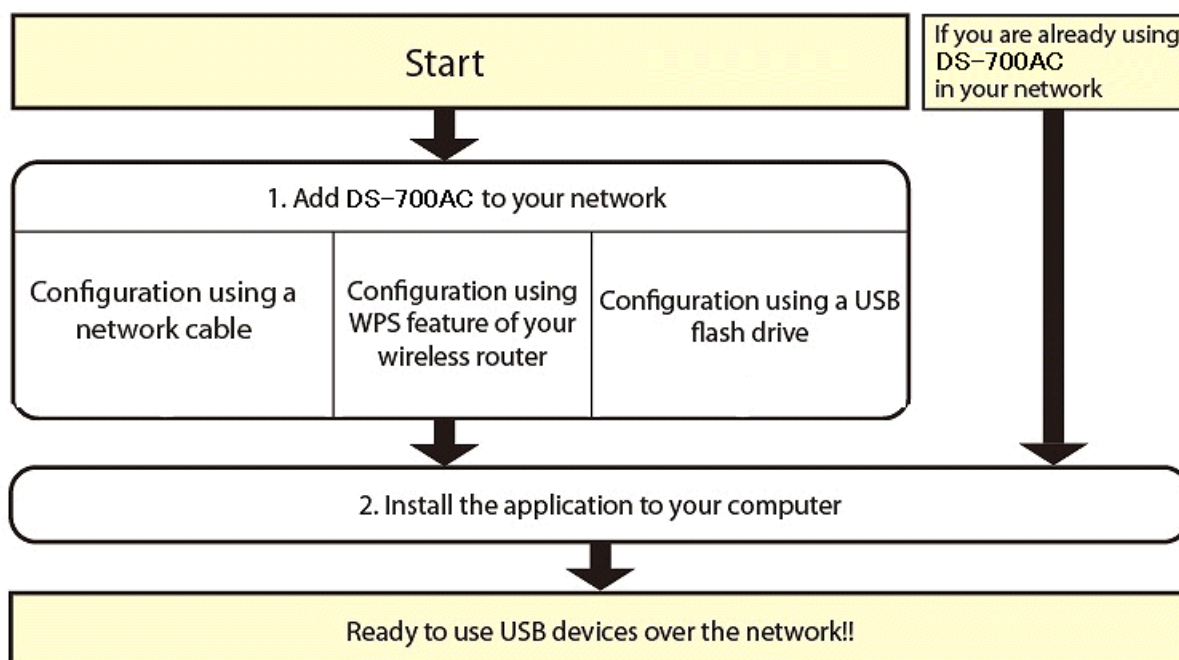

3-3-3. Setup

Setup DS-700AC on your network and get ready to use it from each PC.

There are 3 configuration methods as described below.

1. Setup DS-700AC

Configuration using a network cable

By connecting DS-700AC to your existing network using a network cable, you can configure the network settings from your PC.

Refer to **5-1. Configuration via a Network Cable (Recommended)** for how to configure using a network cable.

Configuration using WPS feature of your wireless router

If your wireless router supports WPS (Wi-Fi Protected Setup), the network configuration can be done automatically by pressing the wireless connection button on your wireless router and the push switch on DS-700AC.

Refer to **5-2. Configuration via WPS** for how to configure using WPS.

Configuration using a USB flash drive

By saving the configuration information to a USB flash drive and connecting it to DS-700AC, you can configure the network settings.

Refer to **5-1. Configuration via a Network Cable (Recommended)** for how to configure using a USB flash drive.

2. Install the necessary applications on your PC.

Refer to **6. Installing the Application to PC** for how to install the necessary applications on your PC.

3-3-4. Prepare other PCs to use DS-700AC

Install the necessary application on all PCs from which you wish to use the USB devices.

Install the necessary application on all PCs that you wish to use.

Refer to **6. Installing the Application to PC** for how to install the necessary applications on your PC.



- Please be sure to read the operation manual of your USB device before you connect it to DS-700AC. The connecting method and position may vary depending on the USB device to be connected.
- Please use the AC adapter bundled with DS-700AC. Other AC adapters may cause unexpected damages.
- If DS-700AC has been used in another network, reset it to the factory default settings before you start the configuration. (Please refer to **8-5-2. Resetting to Factory Defaults** for details.)
- If a USB HUB is used, multiple USB devices can be connected, however, the USB3.0 port does not support connection of a USB HUB. Also, when using a USB HUB for the USB2.0 port, make sure that only one HUB is connected.
- The USB3.0 port of DS-700AC does not support connection with a USB HUB, USB HUB embedded device and USB video converter.
- If you are using the firewall feature of a commercial security application, disable it while you configure DS-700AC. Refer to the FAQ on our homepage (<https://www.silextechnology.com/>) for details.

Blank page

4. Software Overview

4-1. Necessary Utilities

4-1-1. What is Device Server Setup?

This page explains the Device Server Setup used to configure DS-700AC.

Setting TCP/IP

Device Server Setup is the configuration utility exclusively designed for Device Server products. In the TCP/IP setting window of Device Server Setup, you can configure the IP Address of DS-700AC.

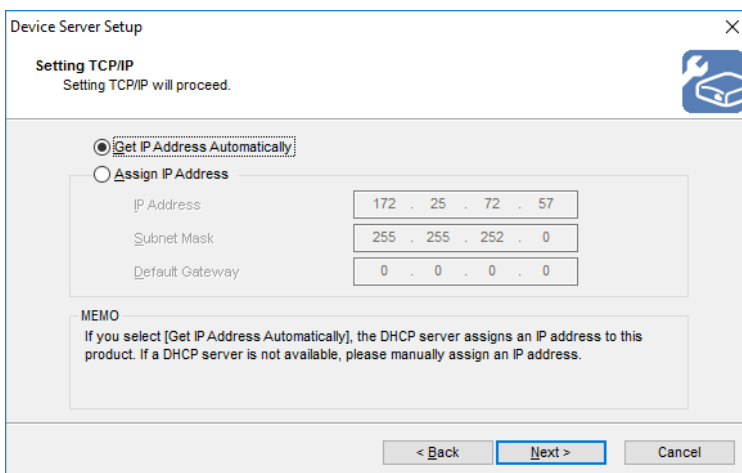

Get IP Address Automatically	Select this to automatically assign an IP Address using the DHCP server.
Assign IP Address	Select this to manually configure IP Address, subnet mask and default gateway.



- Enter a **Subnet Mask** and **Default Gateway** if necessary.
- If there are no DHCP servers on your network and the IP address of your PC is assigned manually, a sample address created with your PC's settings will be displayed in the window below. In such a case, please enter an IP address manually.
The IP address used in the screen below is a sample address. Please specify an IP address appropriate for your environment.

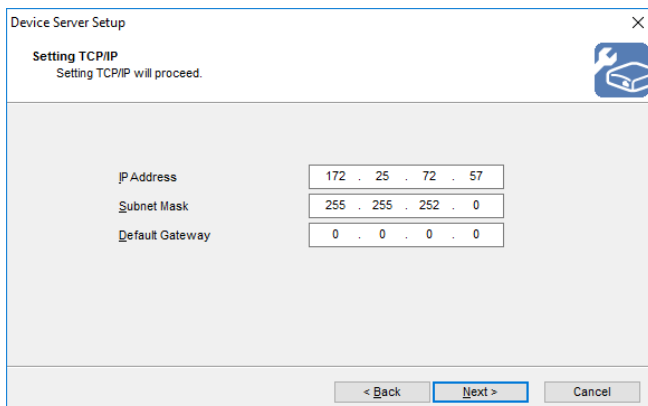

Wireless Setting

After the TCP/IP setting is configured, wireless network can be selected.
Enter the network key and follow the instructions on screen to configure the wireless settings.

Device Server Setup

Wireless Setting
Setting for Wireless usage.

Select the wireless network (SSID of the access point or network device) that you wish to use.

SSID	Channel	Wireless Stand...	Wireless Mode	BSSID
GROUP	1	802.11 a/n/ac	Infrastructure	84253F1977

Network Key:

Confirm Network Key:

Skip wireless configuration

< Back Cancel

Network Key	Enter the WEP Key or Pre-Shared Key of the wireless network you want to connect to.
Confirm Network Key	Select this to manually configure IP Address, subnet mask and default gateway.



Note

- If the wireless network that you wish to use is not shown in the list, click **Detailed Config**.

Device Server Setup

Wireless Setting
Setting for Wireless usage.

Wireless Mode: Infrastructure

SSID: GROUP

Channel:

Network Authentication: Open

Use WEP: ON

Key Size: 64bit (16 hexadecimal)

WEP Key: s i l e x

Key Index: 1

<< Easy Cnfig

< Back Cancel

4-1-2. What is SX Virtual Link?

This page explains the application "SX Virtual Link" that is necessary to use DS-700AC.

About SX Virtual Link

SX Virtual Link allows you to connect your PC to a USB device that is connected to a device server. Use SX Virtual Link when you connect/disconnect to/from the USB device

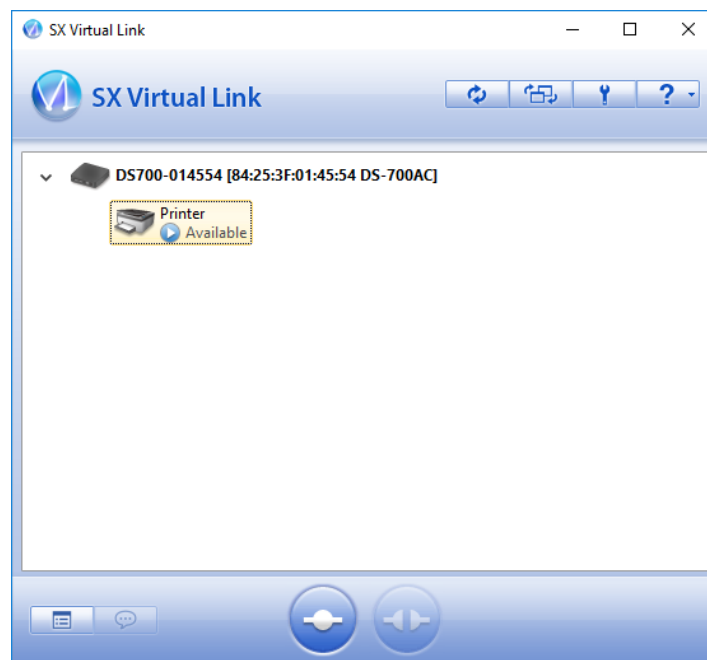

Functional Overview

- Easy to Use

You only have to select the USB device in SX Virtual Link and click the **Connect** button.

The USB device can be used from your PC as if it was directly connected to your PC. When finished using the USB device, click the **Disconnect** button in SX Virtual Link.

- Printer Auto Connection

When you print to a USB printer, SX Virtual Link will automatically connect your PC to the printer. When the print job is complete, SX Virtual Link will disconnect your PC from the USB printer. Thus, you will not have to manually connect/disconnect to/from the USB printer using SX Virtual Link.

- Allows Control from the Task tray

The minimized menu window in the task tray will allow you to connect/disconnect to/from USB devices without displaying SX Virtual Link's main window.

- Send a Remote Message to Another User to Request for Disconnect

When you are sharing a USB device with several users and one of them occupies the USB device for a long time, you can request to the user to disconnect the device by sending a remote message. If the user accepts the disconnect request, the right of use is automatically passed down to you, so that you can use the USB device.

- Operating Settings for Each USB Device

The operational settings such as **Start designated application when connected** or **Automatically connect this device when it is available** can be configured for each USB device.



- Depending on the printing capability of the USB device, the **Printer auto connection** feature may not work properly.



Note

- If you are planning to use a particular USB device alone without sharing it with other users, SX Virtual Link Lite can be used to automatically connect to it when the PC is powered on.
- For details on SX Virtual Link Lite, refer to **8-7. Using SX Virtual Link Lite**.

4-2. Downloading the Utilities

This page explains how to download the necessary utilities.

The utilities to configure and use DS-700AC can be downloaded from our website.

1. Access the URL below on the PC to use to configure DS-700AC.

URL: <https://www.silextechnology.com/>

Product Model	DS-700AC
---------------	----------

2. Go to the **Support** page and select the product model.

3. Download the utilities below and extract them on the PC.

Utilities	Device Server Setup
	SX Virtual Link



Note

- In order to upgrade the firmware version, the firmware file needs to be downloaded

The download is now completed.

5. Configuration

5-1. Configuration via a Network Cable (Recommended)

This page explains how to connect DS-700AC to your existing network using a network cable and configure from your PC.

5-1-1. Necessary Items

The following items are required in order to connect DS-700AC to a network.

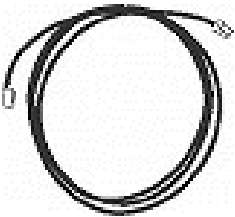
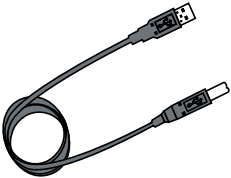
<p>Wireless Router (Ethernet HUB)</p> 	<p>Use to connect DS-700AC and other network devices such as a PC. When there are available LAN ports on the network in which DS-700AC is to be installed, you do not have to purchase a new Ethernet Hub or broadband router as DS-700AC can be connected to the available LAN port.</p>
<p>Network Cable</p> 	<p>Use to connect DS-700AC and network devices such as an Ethernet Hub, broadband router and PC.</p>
<p>USB Cable</p> 	<p>Use to connect DS-700AC and USB devices. A USB Cable is not required if the device is the one that connects itself directly to a USB port (e.g. USB memory) or there is a bundled USB cable.</p>



- In a 100BASE-TX environment, please use Ethernet Hub and network cable that support 100BASE-TX network (category 5 or above).
- In a 1000BASE-T environment, please use Ethernet Hub and network cable that support 1000BASE-T network (category 5e or above).
- For a USB cable, it is recommended to use the one with a USB logo certification.
- The USB3.0 port of DS-700AC does not support connection with a USB HUB, USB HUB embedded device and USB video converter.

5-1-2. Start Setup

Connect a network cable to and power on DS-700AC

1. Connect a network cable to DS-700AC and the other end to an Ethernet Hub or wireless router.

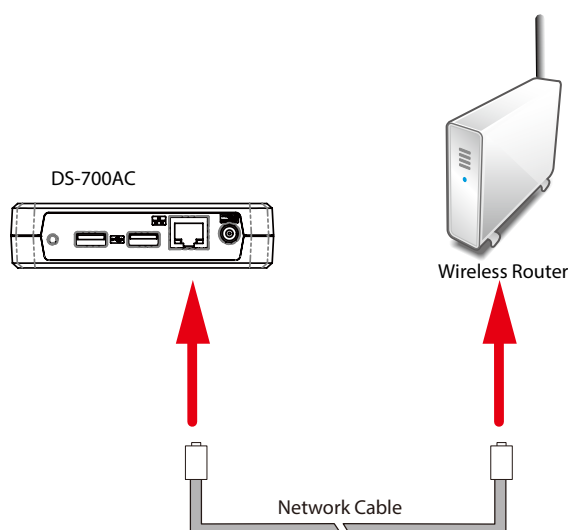

2. Connect an AC adaptor to DS-700AC(1) and power plug to an outlet(2).

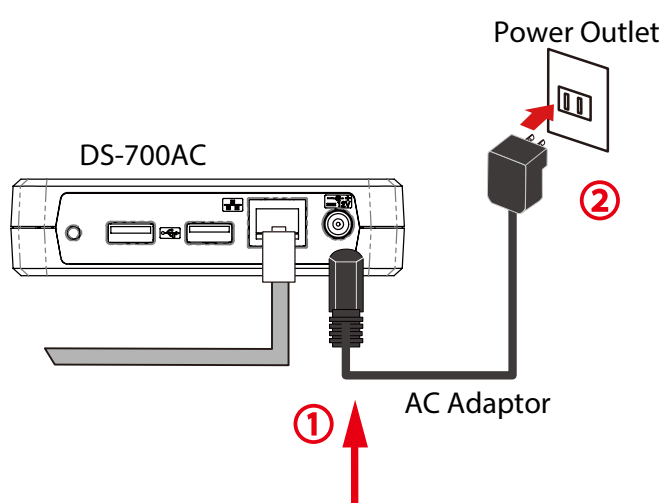

3. Check that the **POWER LED** turns on.

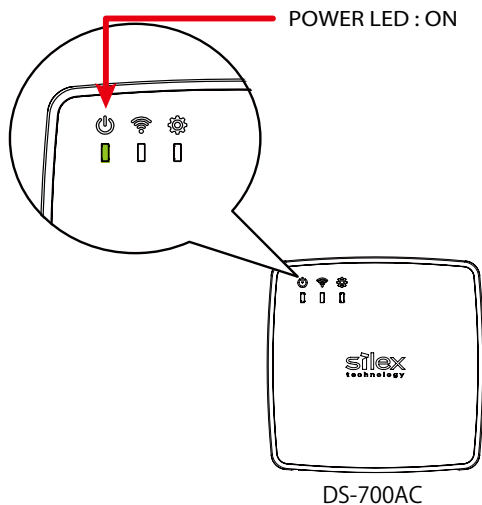

Note

- In the following cases, DS-700AC is not connected to a wired network. Go back to 2-1. Connect a network cable to and power on DS-700AC and follow the instructions again.
- If the POWER LED is off, DS-700AC is not powered on. Check that the AC adaptor is plugged in properly.
- If the WLAN LED is on, the network cable is not connected. Check that the network cable is plugged in properly.
- If the WLAN LED is on even though the network cable is plugged in properly, DS-700AC may have the setting which does not allow a wired LAN connection. In such a case, reset DS-700AC to factory defaults. For details on how to reset DS-700AC to factory defaults, refer to **8-5-2. Resetting to Factory Defaults**.

Configure the network settings from your PC

- 1.** Extract the downloaded Device Server Setup file on your desktop. Double-click **Dssetup.exe** to start the Device Server Setup utility.
- 2.** Click **Device Server Configuration**.

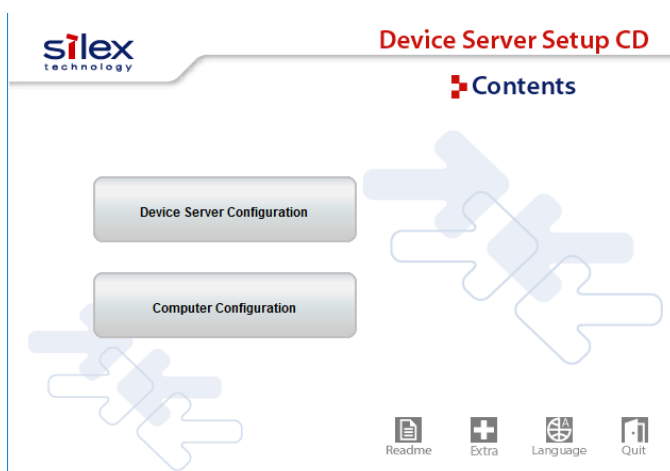

3. Click **Configure using the setup utility (Recommended)**.

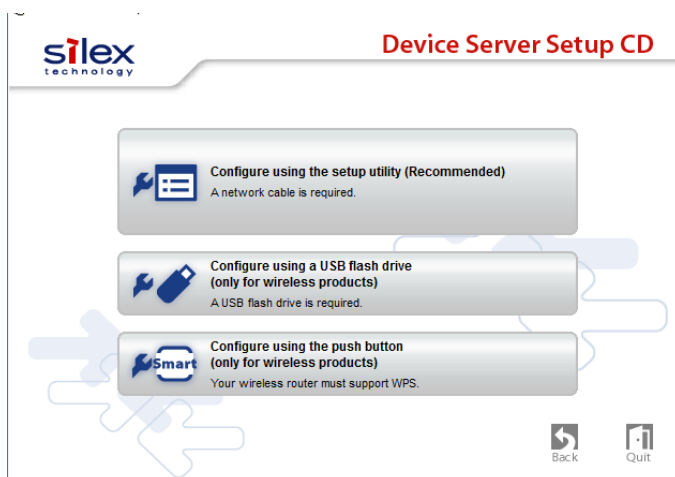

4. The **User Account Control** window is displayed. Click **Yes**.

5. Click **Yes** in the message below.

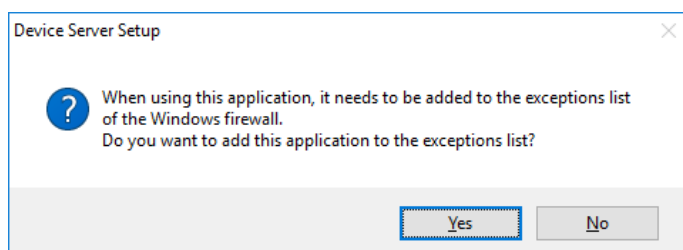

6. Device Server Setup is displayed. Click **Next**.



7. Read the software license agreement and click **Yes**.

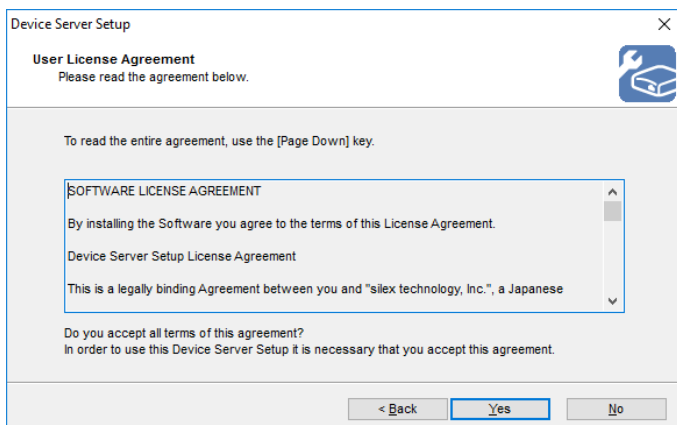

8. Select DS-700AC and click **Next**.

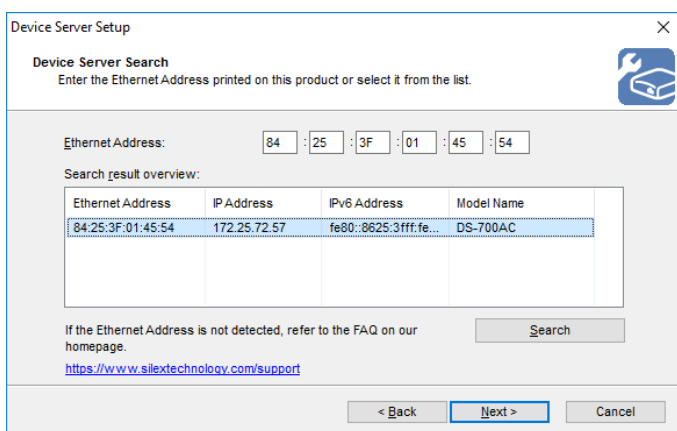

- If DS-700AC is not displayed in the list, click **Search**.
 - If this does not help, refer to **9-2-1. Problems During Setup - DS-700AC is not displayed in the search result of the Device Server Setup** in Troubleshooting.

Note

9. Configure the TCP/IP settings appropriate for your environment.



- If you are not sure how to determine the IP address to set, refer to **9-2-1. Problems During Setup-How should I determine the way to assign an IP address to DS-700AC** in Troubleshooting.

Note

<< When obtaining an IP address automatically from a DHCP server >>
Select **Get IP Address Automatically** and click **Next**.

Device Server Setup

Setting TCP/IP
Setting TCP/IP will proceed.

Get IP Address Automatically

Assign IP Address

IP Address: 172 . 25 . 72 . 57

Subnet Mask: 255 . 255 . 252 . 0

Default Gateway: 0 . 0 . 0 . 0

MEMO
If you select [Get IP Address Automatically], the DHCP server assigns an IP address to this product. If a DHCP server is not available, please manually assign an IP address.

< Back Next > Cancel

<< When assigning an IP address manually >>
Select **Assign IP Address**, enter an IP address and click **Next**.

Device Server Setup

Setting TCP/IP
Setting TCP/IP will proceed.

Get IP Address Automatically

Assign IP Address

IP Address: 172 . 25 . 72 . 57

Subnet Mask: 255 . 255 . 252 . 0

Default Gateway: 0 . 0 . 0 . 0

MEMO
If you select [Get IP Address Automatically], the DHCP server assigns an IP address to this product. If a DHCP server is not available, please manually assign an IP address.

< Back Next > Cancel



TIP

- The IP address used in the above screen is a sample address. Please specify an IP address appropriate for your environment.
- Enter a **Subnet Mask** and **Default Gateway** if necessary.
- If there are no DHCP servers on your network and the IP address of your PC is assigned manually, a sample address created with your PC's settings will be displayed in the window below. In such a case, please enter an IP address manually.

Device Server Setup

Setting TCP/IP
Setting TCP/IP will proceed.

IP Address: 172 . 25 . 72 . 57

Subnet Mask: 255 . 255 . 252 . 0

Default Gateway: 0 . 0 . 0 . 0

< Back Next > Cancel

10. If you plan to use DS-700AC in a wireless network, select the wireless network that you wish to connect to from a list. Enter the network key that you have checked at **3-2. Necessary Wireless Setting Information** for **Network Key** and **Confirm Network Key** respectively and click **Next**.

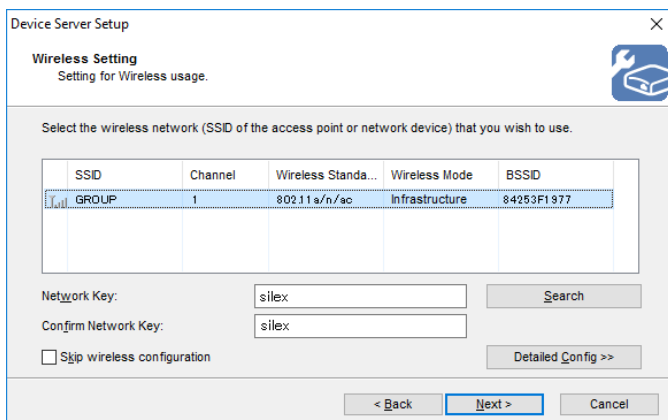

Note

- If the wireless network that you wish to use is not shown in the list, click **Detailed Config** and configure each setting.

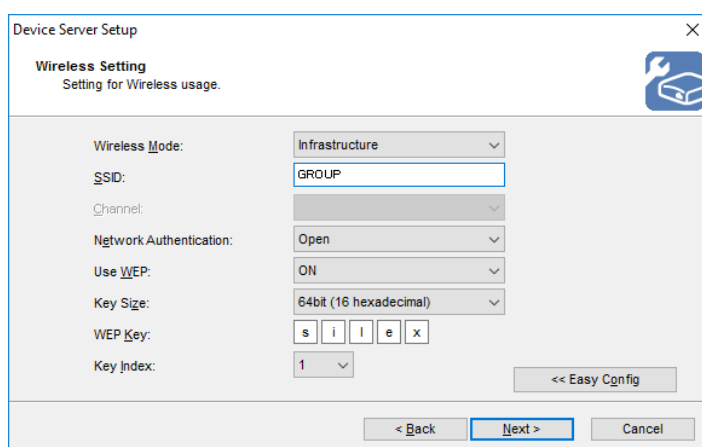

- If you will use DS-700AC in a wired network after finishing the configuration, check **Skip wireless configuration** and click **Next**.

11. Check the settings and click **Execute**.

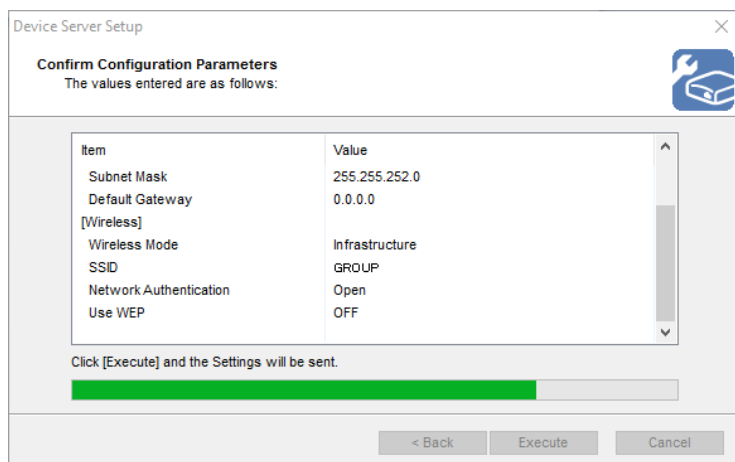

Device Server Setup

Confirm Configuration Parameters
The values entered are as follows:

Item	Value
Subnet Mask	255.255.252.0
Default Gateway	0.0.0.0
[Wireless]	
Wireless Mode	Infrastructure
SSID	GROUP
Network Authentication	Open
Use WEP	OFF

Click [Execute] and the Settings will be sent.

< Back Execute Cancel



- The information displayed here will differ depending on your selection.



Note

- If an error occurs after clicking Execute, please refer to **9-2-1. Problems During Setup - Communication error occurs when configuring with Device Server Setup** in Troubleshooting.

12. To take effect of the settings, restart DS-700AC. Go on to **5-1-3. Enable the new settings**.

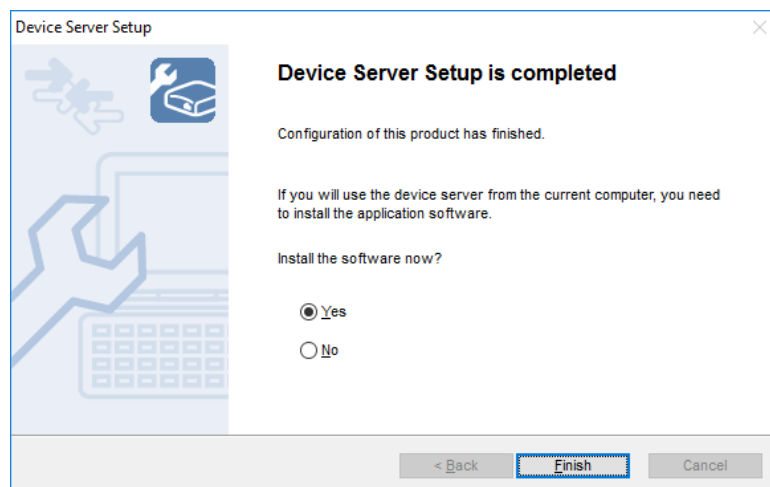

Device Server Setup

Device Server Setup is completed

Configuration of this product has finished.

If you will use the device server from the current computer, you need to install the application software.

Install the software now?

Yes

No

< Back Finish Cancel

5-1-3. Enable the new settings

The following explains how to activate the new settings.

1. Remove the AC plug from the power outlet(1) and the network cable from DS-700AC(2).

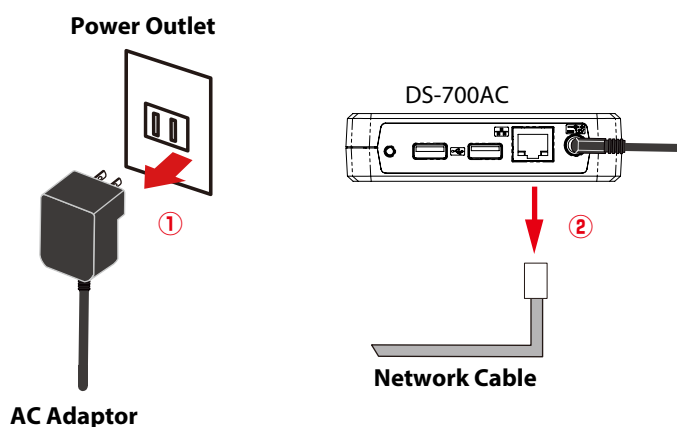

- If you plan to use DS-700AC on a wired network, it is not necessary to unplug the network cable.

2. Connect the USB device that you wish to use over the network to DS-700AC using a USB cable(1) and then insert the AC plug of DS-700AC into the power outlet(2).

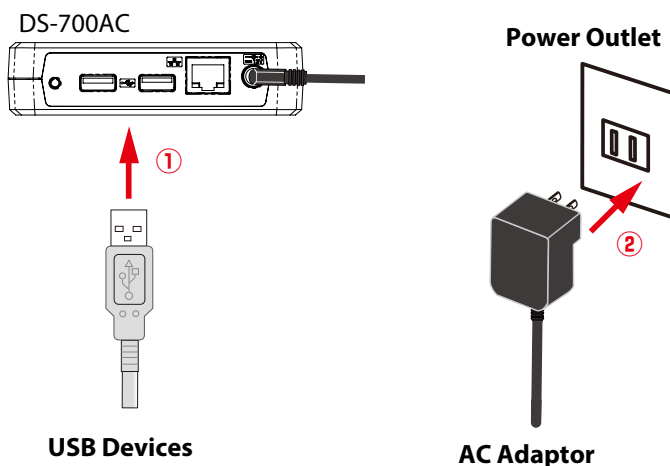

3. Check that the **WLAN LED** turns Green.

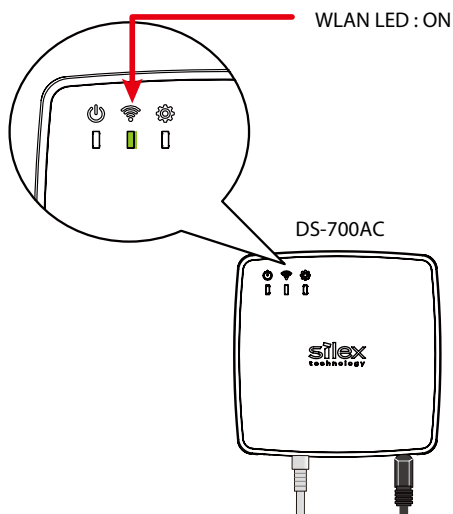

Tip

- In the following cases, DS-700AC is not connected to a wireless network.
 - If the POWER LED is off, DS-700AC is not powered on. Check that the AC adaptor is plugged in properly.
 - If the WLAN LED blinks orange, DS-700AC is still searching for a wireless network. Please wait for a while.
 - If the WLAN LED does not turn Green within 2-3 min, DS-700AC's wireless settings may not have been configured properly. In such a case, go back to **3-2. Necessary Wireless Setting Information** and check the wireless setting information once again.
 - If the Wireless LED is off, the network cable is plugged in.
 - If you plan to use DS-700AC in a wireless network, go back to **step1** at **5-1-3. Enable the new settings**.
 - If you plan to use DS-700AC in a wired network, check the WLAN LED turns off.

4. Select **Yes** or **No** and click **Finish**.



Tip

- If you plan to use the Device Server feature, click **Yes**.
- In the following cases, click **No**. SX Virtual Link does not need to be installed.
 - If you do not plan to use the Device Server feature from the PC used for this setup.
 - If you will only use a printer with standard Windows printing.



The setup is now complete.

To use the Device Server feature, go on to install the software, "**SX Virtual Link**".

For details on how to install SX Virtual Link, refer to **6. Installing the Application to PC**.

To use Print Server feature, configure the necessary settings for standard Windows printing.

For details on the Print Server feature, refer to **8-2. About the Print Server Feature**.

5-2. Configuration via WPS

This page explains the easy wireless configuration method using WPS (Wi-Fi Protected Setup) feature of your wireless router.

5-2-1. Confirm that your wireless router supports WPS

To perform the wireless configuration using WPS, your wireless router must support WPS. Please make sure that a wireless router supporting WPS is set up in your environment.

To see if your wireless router supports WPS or not, refer to the operation manual that came with the router or contact the manufacturer.



Tip

- Depending on your wireless router, WPS may need to be enabled manually. For details, refer to the operation manual that came with your wireless router.
- If a security feature such as MAC Address filtering is enabled on your wireless router, disable it temporarily so that DS-700AC can communicate with your wireless router.

5-2-2. Prepare the necessary items

Prepare the necessary items

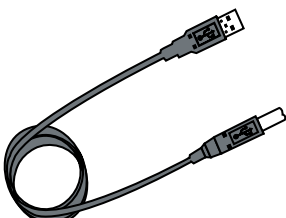
<p>USB Cable</p> 	<p>A USB Cable is not required if the device is the one that connects it self directly to a USB port (e.g. USB flash drive) or there is a bundled USB cable.</p>
--	--



Tip

- For a USB cable, it is recommended to use the one with a USB logo certification.

5-2-3. Start setup

Configure the wireless settings using WPS of your wireless router.



Tip

- The name, position and shape of the wireless connection button will differ depending on your wireless router. For details, refer to the operation manual that came with your wireless router.
- Please use only one wireless router. If two or more routers are waiting for wireless connections, DS-700AC will not be able to connect properly.
- While performing this configuration, please temporarily move DS-700AC closer to your wireless router to make it easier for both devices to communicate.

1. Connect the AC adaptor to DS-700AC and the AC plug to the power outlet.

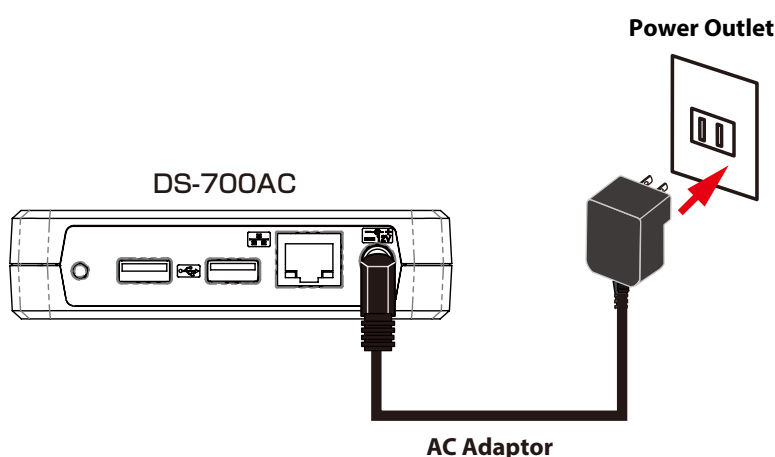

2. Confirm that the WLAN LED on DS-700AC blinks orange or turns green.

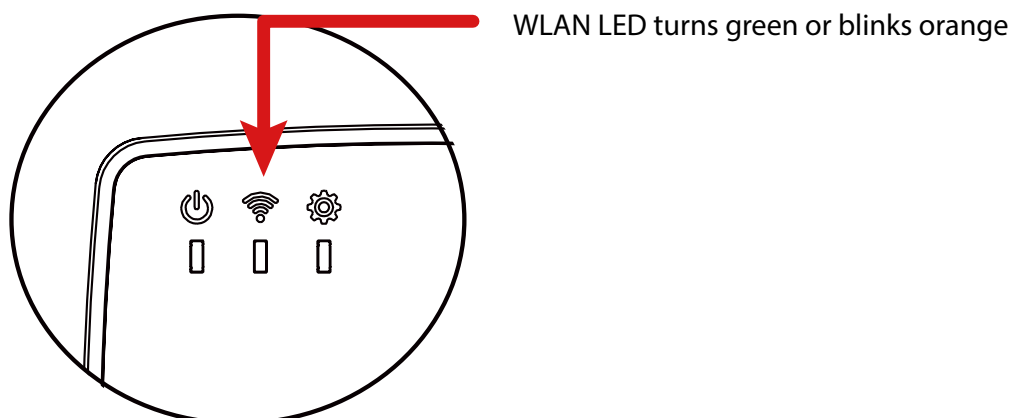

Tip

- If the WLAN LED does not blink orange or turn green, reset DS-700AC to factory defaults and start from step 1 again.
- For how to reset DS-700AC to its factory defaults, refer to the **8-5-2. Resetting to Factory Defaults.**

3. Press the WPS button on your wireless router.
Confirm that your wireless router is ready for a wireless connection to be made.

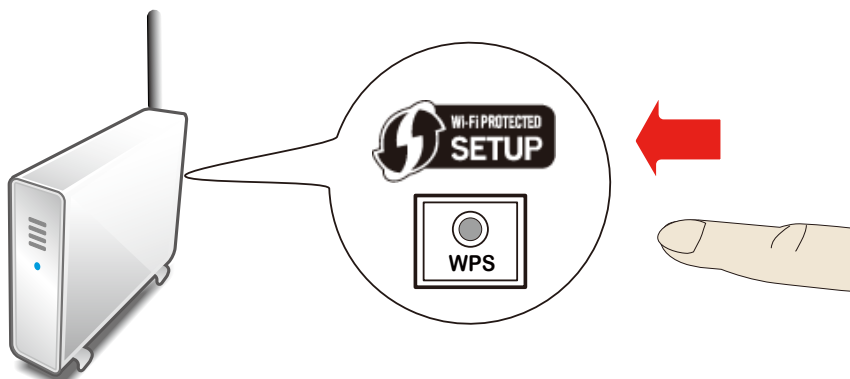

Wireless Router



Tip

- The name, position and shape of the WPS button will differ depending on your wireless router. For details, refer to the operation manual that came with your wireless router.
- Please use only one wireless router. If two or more routers are waiting for wireless connections, DS-700AC will not be able to connect properly.

4. Press and hold the push switch on DS-700AC. When the WLAN LED blinks green, release the push switch.

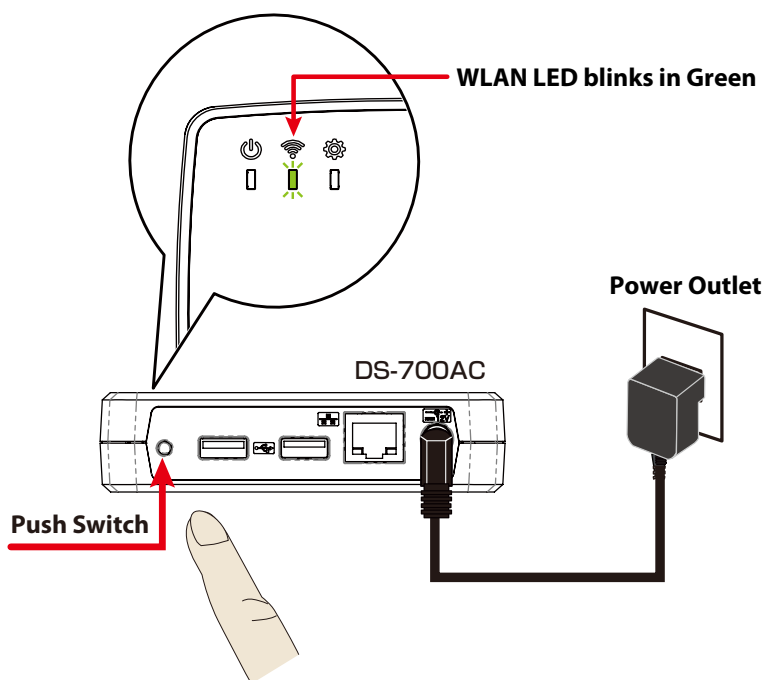

Tip

- Within 3-10 sec after pressing and holding down the push switch, the WLAN LED will blink green.

5. DS-700AC will start to communicate with your wireless router.
The WLAN LED's lighting pattern will show you if the wireless configuration succeeded or failed.

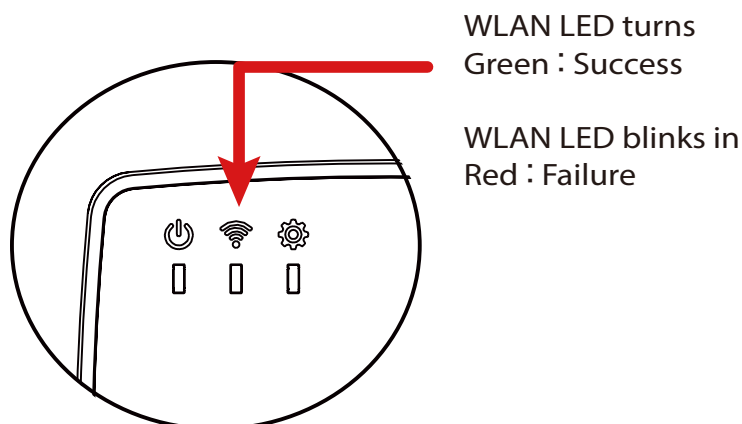

- It may take a while to complete the wireless configuration depending on your environment (up to 2 min).

○ When successful, the WLAN LED will turn to Green.
In this case, wireless configuration is complete.

- Power off DS-700AC, move it to where you wish to use it and then power it on again.
- Connect the USB device(s) that you wish to use over the network to DS-700AC.

※ It is not necessary to install the applications if you plan to use printers with the standard windows printing feature.

✗ When wireless configuration has failed, the WLAN LED will blink in Red.
Read the instructions on this sheet and start from step 3 again.

To use the Device Server feature, go on to install the software, "**SX Virtual Link**".
For details on how to install SX Virtual Link, refer to **6. Installing the Application to PC**.
To use Print Server feature, configure the necessary settings for standard Windows printing.
For details on the Print Server feature, refer to **8-2. About the Print Server Feature**.

5-3. Configuration via a USB Flash Drive

This page explains how to configure the network settings using a USB flash drive. By saving the configuration information to a USB flash drive and connecting it to DS-700AC, you can configure the network settings. To save the configuration information to the USB flash drive, use the configuration utility downloaded from our website.

5-3-1. Necessary Items

The following items are required in order to connect DS-700AC to a network.

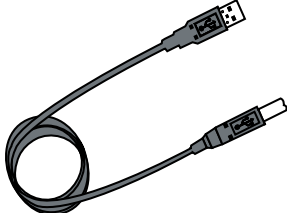
<p>USB Flash Drive</p> 	<p>For saving the configuration information that will be used for setup. Please use a drive formatted in FAT32. Only a few KB of space is required and it is OK if there are other files present.</p>
<p>USB Cable</p> 	<p>Use to connect DS-700AC and USB devices. A USB Cable is not required if the device is the one that connects itself directly to a USB port (e.g. USB flash drive) or there is a bundled USB cable.</p>



Tip

- For a USB cable, it is recommended to use the one with a USB logo certification.
- If the USB flash drive is not formatted in FAT32, the configuration information is not transferred to DS-700AC correctly.

5-3-2. Start Setup

Save the configuration information to a USB flash drive

1. Extract the downloaded Device Server Setup file on your desktop.
Double-click **Dssetup.exe** to start the Device Server Setup utility.
2. Click **Device Server Configuration**.

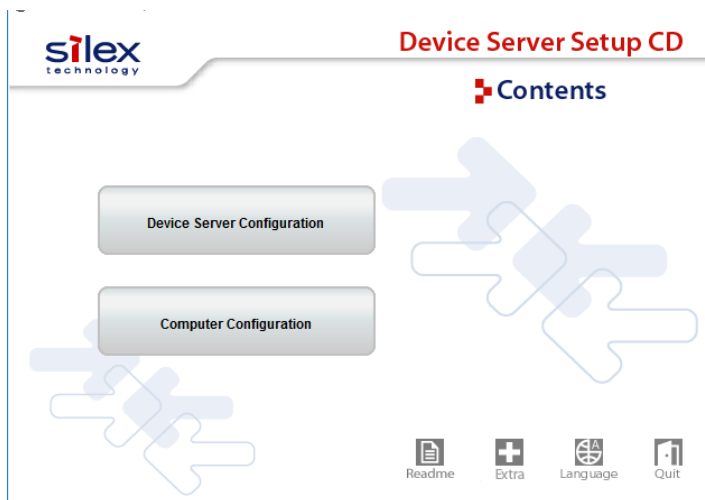

3. Click **Configure using a USB flash drive**.

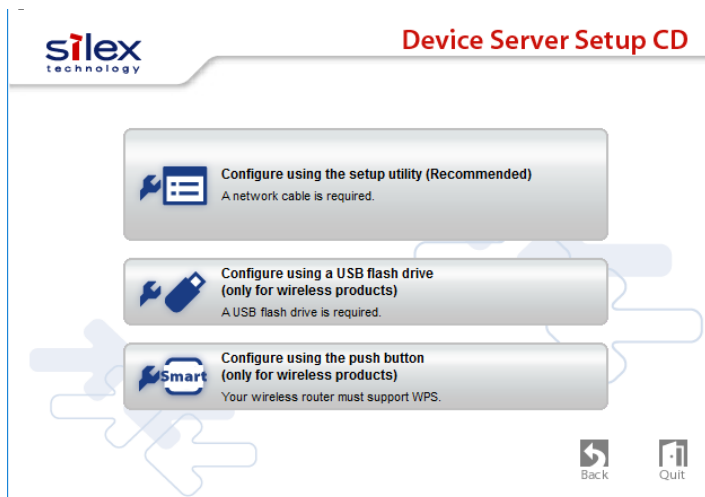

4. The **User Account Control** window is displayed. Click **Yes**.

5. Device Server Setup is displayed. Click **Next**.



6. Read the software license agreement and click **Yes**.

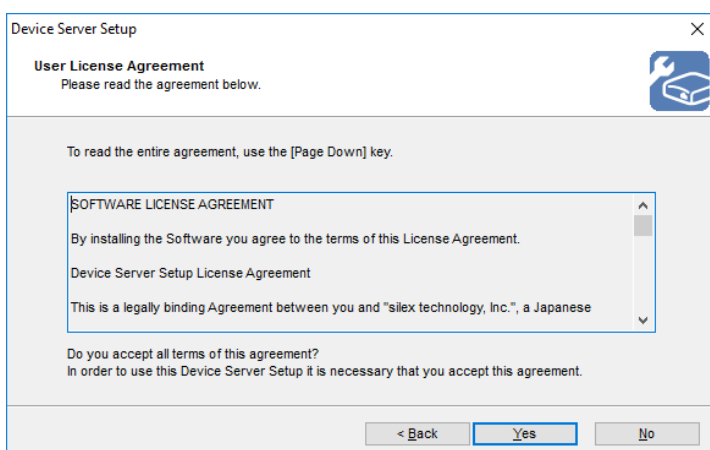

7. Insert the USB flash drive into your PC and click **Next**.

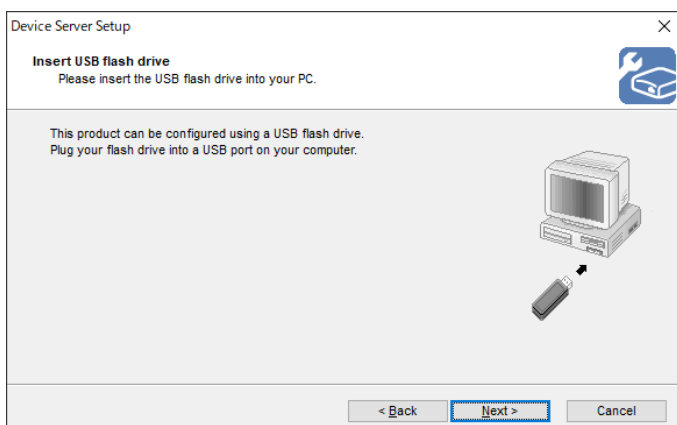

- Select the USB flash drive that you have inserted from a list and click **Next**.

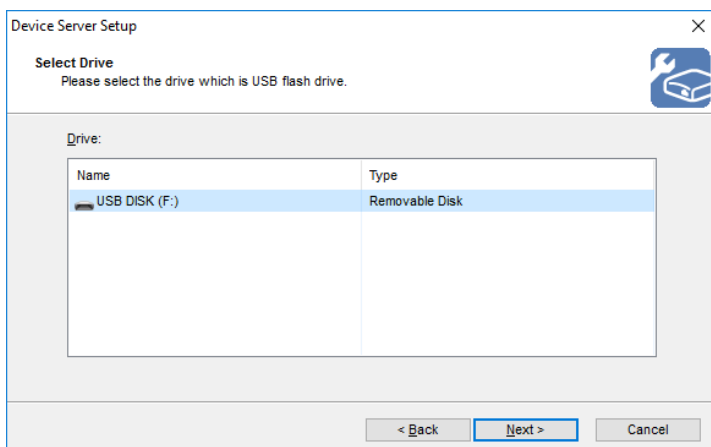

- Configure the TCP/IP settings appropriate for your environment.



Note

- If you are not sure how to determine the IP address to set, refer to **9-2-1. Problems During Setup-How should I determine the way to assign an IP address to DS-700AC?**

<< **When obtaining an IP address automatically from a DHCP server** >>

Select **Get IP Address Automatically** and click **Next**.

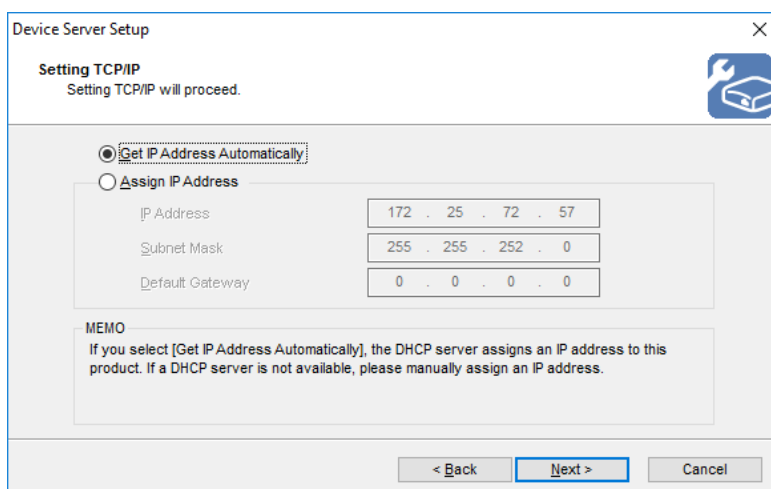

<< **When assigning an IP address manually** >>

Select **Assign IP Address**, enter an IP address and click **Next**.

Device Server Setup

Setting TCP/IP
Setting TCP/IP will proceed.

Get IP Address Automatically
 Assign IP Address

IP Address	172 . 25 . 72 . 57
Subnet Mask	255 . 255 . 252 . 0
Default Gateway	0 . 0 . 0 . 0

MEMO
If you select [Get IP Address Automatically], the DHCP server assigns an IP address to this product. If a DHCP server is not available, please manually assign an IP address.

< Back **Next >** Cancel



- The IP address used in the above screen is a sample address. Please specify an IP address appropriate for your environment
- Enter a **Subnet Mask** and **Default Gateway** if necessary.

- 10.** If you plan to use DS-700AC in a wireless network, configure the wireless settings. Enter the wireless settings that you have checked at **3-2. Necessary Wireless Setting Information** and click **Next**.

Device Server Setup

Setting Wireless
Configure the desired device server wireless settings.

Skip wireless configuration

Wireless Mode: Infrastructure

SSID: GROUP

Channel: 11

Network Authentication: Open

Use WEP: ON

Key Size: 64bits (ASCII string)

WEP Key: silex

Key Index: 1

< Back **Next >** Cancel



- For details on the each setting, refer to **3-2. Necessary Wireless Setting Information**.
- If you will use DS-700AC on a wired network upon completing the configuration, check **Skip wireless configuration** and click **Next**.

11. Check the settings and click **Execute**.

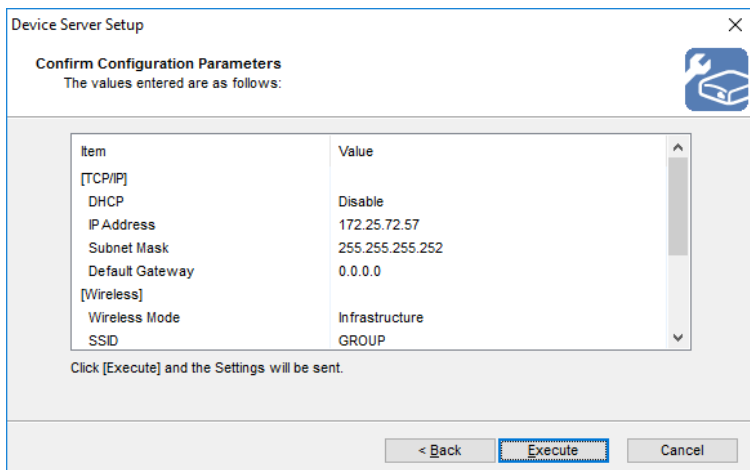

- The information displayed here will differ depending on your selection.

12. Before clicking **Next**, follow the instructions on the window. Remove the USB flash drive from your PC and go on to **5-3-2. Start Setup - Insert the USB flash drive into DS-700AC.**

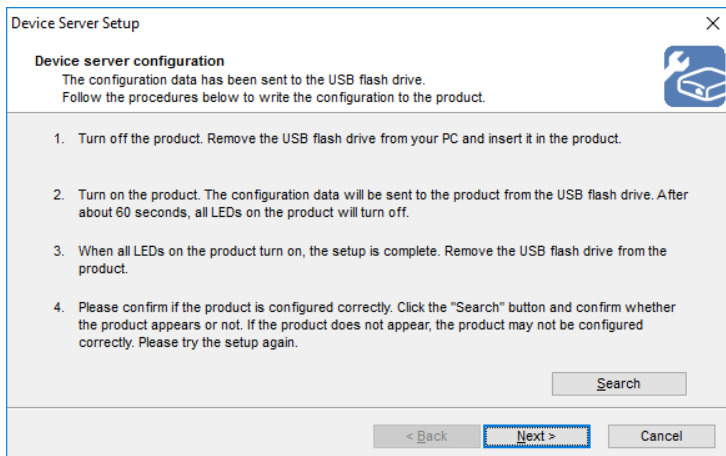

Insert the USB flash drive into DS-700AC

1. Insert the USB flash drive into DS-700AC.

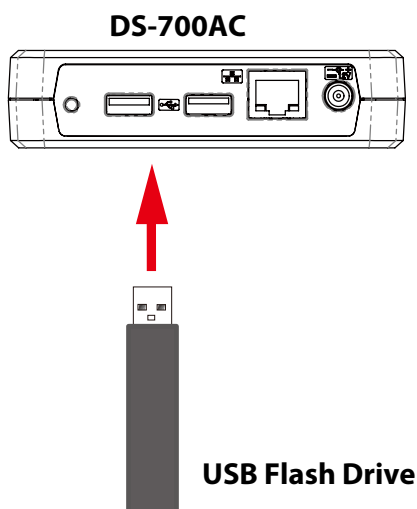

- If you plan to use DS-700AC in a wired network, connect a network cable to DS-700AC.
- If an AC adaptor is connected to DS-700AC, unplug the power plug from an outlet first.

2. Connect the AC adaptor to DS-700AC(1) and the power plug to an outlet(2).
The configuration information will be transferred from the USB flash drive to DS-700AC. When it is successfully finished, all LEDs on DS-700AC will turn off and then POWER LED will turn green.

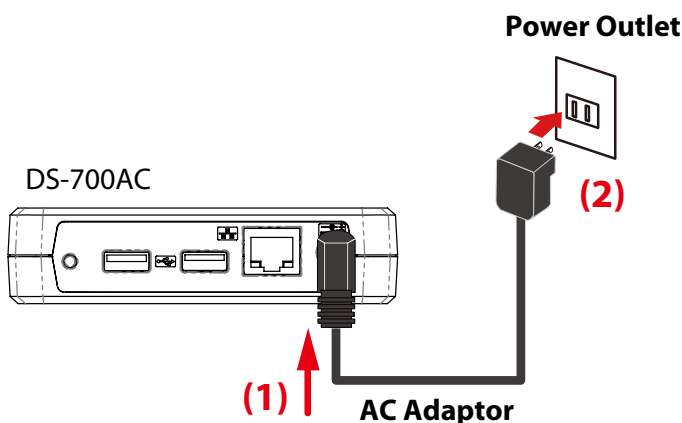

- After the configuration information is transferred from the USB flash drive, DS-700AC will automatically reboot itself. It takes about 60 seconds to complete the transmission and reboot. Please do not remove the USB flash drive from DS-700AC until the POWER LED turns on.
- If all LEDs do not turn off within 60 seconds after DS-700AC is powered on, you may have one of the following problems. Check your settings again.
 - The USB flash drive is not formatted in FAT32.
 - There were no changes detected in the saved configuration information when compared to the current settings of DS-700AC.
 - The configuration information saved in the USB flash drive is not valid.

3. Confirm that the WLAN LED blinks orange and then turns green.

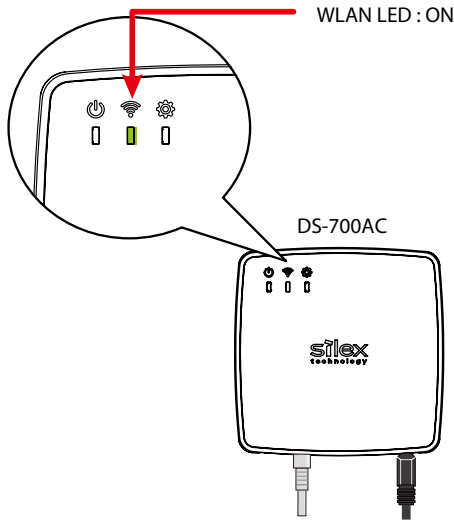

- In the following cases, DS-700AC is not connected to a wireless network.
- If the WLAN LED blinks orange, DS-700AC is still searching for a wireless network. Please wait for a while.
If the WLAN LED does not turn Green within 2-3 min, DS-700AC's wireless settings may not have been configured properly. In such a case, go back to **3-2. Necessary Wireless Setting Information** and check the wireless setting information once again.
- If the Wireless LED is off, the network cable is plugged in.
If you plan to use DS-700AC in a wireless network, unplug the network cable and restart DS-700AC.
If you plan to use DS-700AC in a wired network, check the WLAN LED turns off.

Remove the USB flash drive from DS-700AC

1. Remove the USB flash drive from DS-700AC(1) and connect the USB devices that you wish to use over the network to DS-700AC using a USB cable(2).

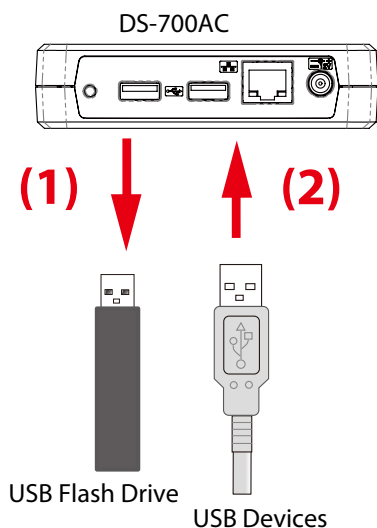

2. Click **Next**.

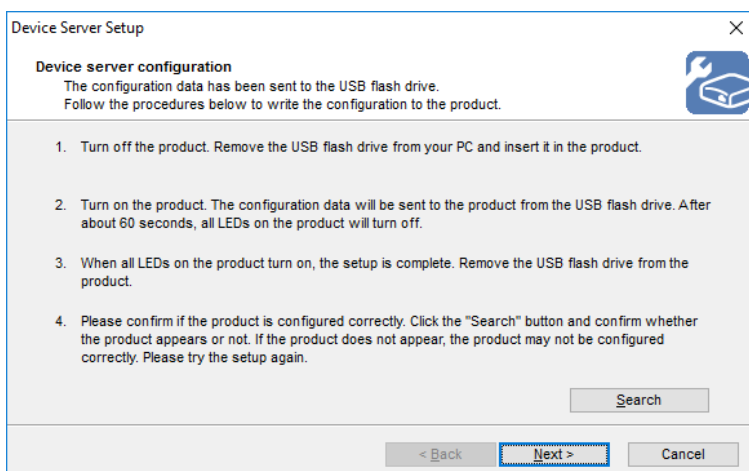

Note

- If **Search** button is clicked, DS-700AC that can be accessed from your PC will be displayed in a list.

3. Select **Yes** or **No** and click **Finish**.



Tip

- If you plan to use the Device Server feature, click **Yes**.
- In the following cases, click **No**. SX Virtual Link does not need to be installed.
 - If you do not plan to use the Device Server feature from the PC used for this setup.
 - If you will only use a printer with standard Windows printing.

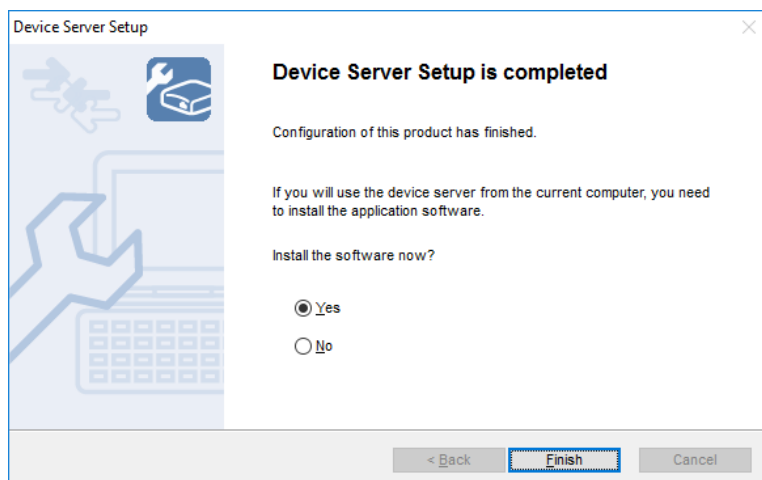

The setup is now complete.

To use the Device Server feature, go on to install the software, "**SX Virtual Link**".
For details on how to install SX Virtual Link, refer to **6. Installing the Application to PC**.

To use Print Server feature, configure the necessary settings for standard Windows printing.
For details on the Print Server feature, refer to **8-2. About the Print Server Feature**.

Blank page

6. Installing the Application to PC

6-1. Installing the Application in Windows

This page explains how to install the USB device connection utility "SX Virtual Link" on window environment.

Install SX Virtual Link according to the instructions below.

If you have completed the configuration and continue to install the application, start from 3 in this section.



- For details on how to download the "SX Virtual Link", refer to **4-2. Downloading the Utilities.**
- Administrator privilege is required for installation.

1. Extract the downloaded SX Virtual Link file on your desktop.
Double-click **Cosetup.exe** to start the SX Virtual Link installer.



- In Windows 7 or Newer, the User Account Control screen is displayed. Click **Yes**.

2. The **User Account Control** window is displayed. Click **Yes**.

3. Select your language and click **Next**.

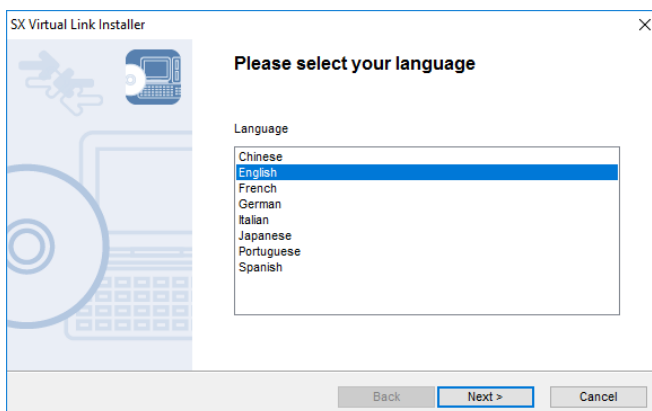

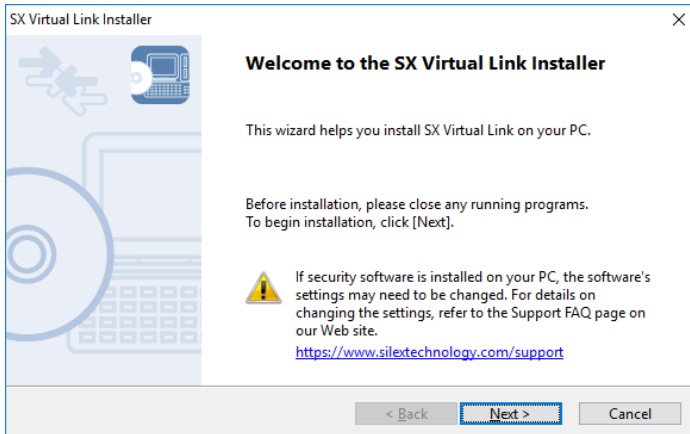
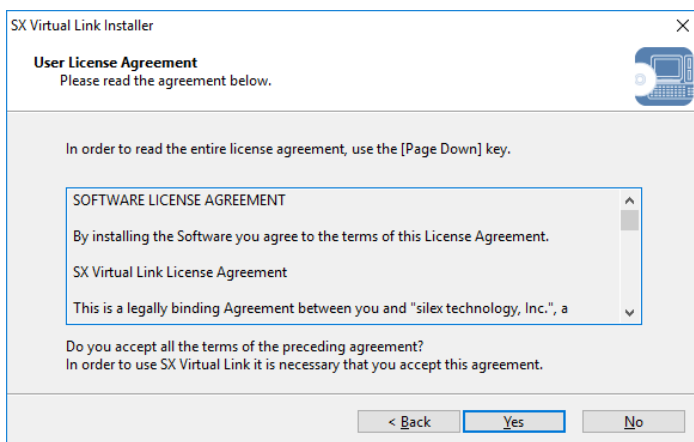
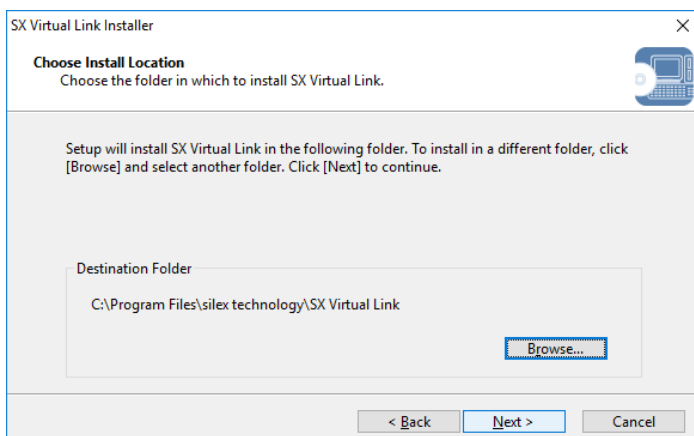

4. SX Virtual Link Install wizard is displayed. Click **Next**.**5.** Read the **SOFTWARE LICENSE AGREEMENT** and click **Yes**.**6.** Select a folder to install SX Virtual Link into and click **Next**.

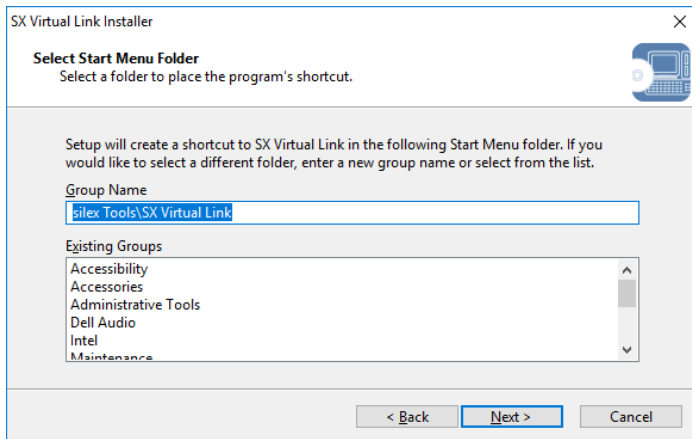
7. Enter a Group Name to be displayed in the Start Menu. Click **Next**.

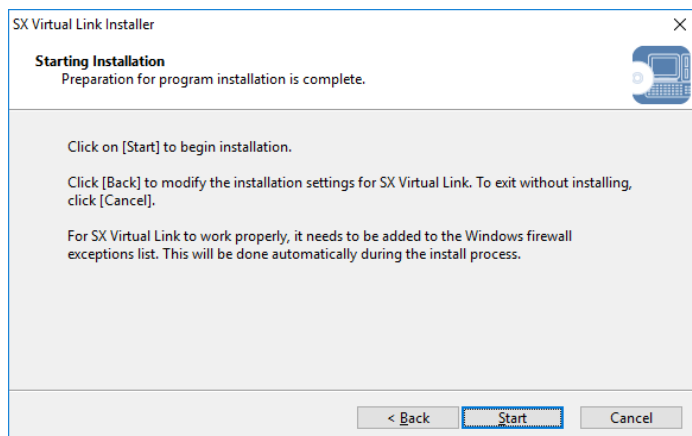

8. Click **Start** to begin the installation.



 - When Windows Security screen is displayed, click **Install**.

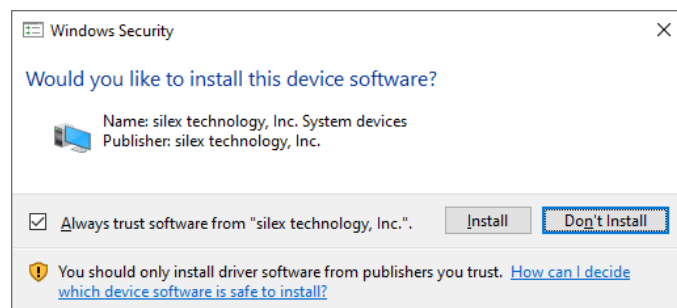

9. SX Virtual Link has been installed. Click **Finish**.

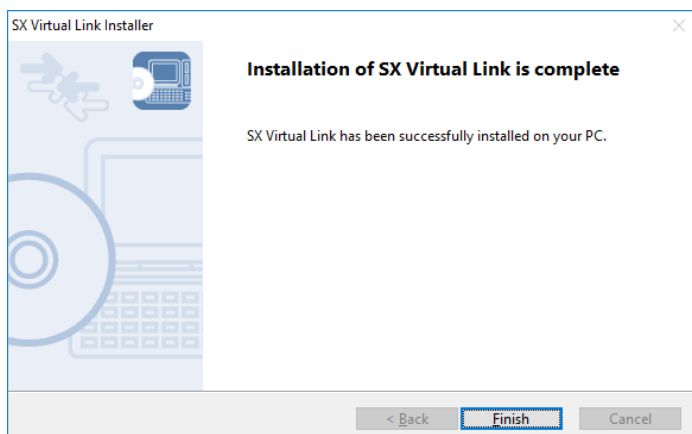

- Restart your PC when it is required by the system.
- If using a firewall function of commercial security software, please add SX Virtual Link to the exception list in your security software. Refer to the FAQ on our website (<https://www.silextechnology.com/>) for details on adding an application to the exception list.

SX Virtual Link has been installed on your PC.

Refer to **7-1. Using USB Devices in Windows** for how to use the USB devices.



- For how to uninstall SX Virtual Link, refer to **8-8-1. Uninstalling SX Virtual Link**.

Blank page

7. Using USB Devices Connected to DS-700AC

7-1. Using USB Devices in Windows

This page explains how to use USB devices connected to DS-700AC after installing SX Virtual Link on Windows.

7-1-1. Starting SX Virtual Link

How to start SX Virtual Link:

1. Click the SX Virtual Link icon () in the task tray.

**Note**

- If SX Virtual Link is not running, click **Start - (All apps) - silex Tools - SX Virtual Link**.
- In Windows 7, click the () button on the notification area (bottom right corner of your desktop) to display the tasktray icons.

2. The SX Virtual Link's main window appears. The USB devices running on a network are displayed in the device list.

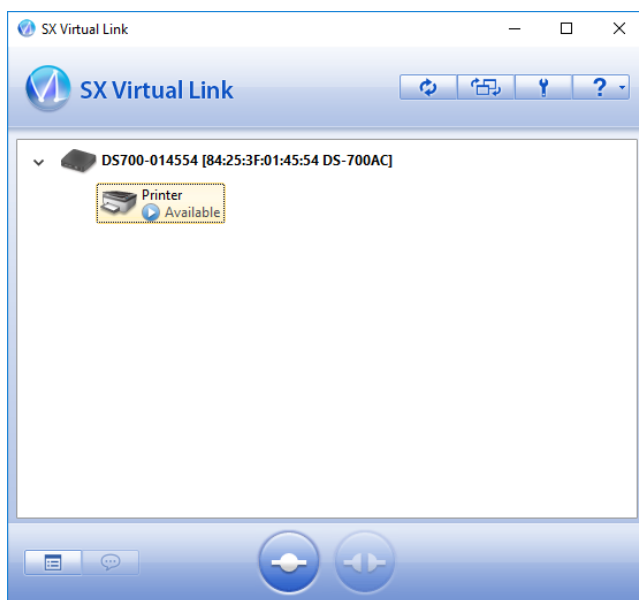
**Note**

- SX Virtual Link can be set to automatically run at startup as a minimized application in the task tray by changing the optional settings. For details on optional settings, refer to **7-1-4. Online Help**.

7-1-2. Connecting / Disconnecting to / from a USB device

Basic usage of a USB device:

1. Select the USB device in SX Virtual Link's main window and connect to it.
2. When successfully connected to the USB device, PC Plug and Play will run and the USB device will become ready to use.
3. When finished using the USB device, disconnect it using SX Virtual Link.

How to connect:

Double-click	Double-click the USB device in SX Virtual Link's main window.
Use a button	Select the USB device and click the Connect button () in SX Virtual Link's main window. If you select two or more USB devices, you can connect to them at once.
Right-click	Right-click on the USB device in SX Virtual Link's main window and click Connect in the menu displayed. If you select two or more USB devices, you can connect to them at once.
Use a keyboard	Select the USB device using the up/down arrow keys and press Alt + C on your keyboard.

How to disconnect:

Double-click	Double-click the USB device in SX Virtual Link's main window.
Use a button	Select the USB device and click the Disconnect button () in SX Virtual Link's main window.
Right-click	Right-click on the USB device in SX Virtual Link's main window and click Disconnect in the menu displayed.
Use a keyboard	Select the USB device using the up/down arrow keys and press Alt + D on your keyboard.



- If a USB device is shared among several users, make sure that each user disconnects from the USB device after they have finished using it. Otherwise, other users will not be able to connect to the USB device.



- For details on how to use SX Virtual Link, refer to the **7-1-4. Online Help**.

7-1-3. Finishing SX Virtual Link

How to finish SX Virtual Link:

1. Click the close button on SX Virtual Link.



- When **Hide the main window if the close button is clicked** setting is enabled on the SX Virtual Link's optional setting, right-click on the SX Virtual Link's icon () in tasktray and select Exit from the menu.

2. When USB device is in use, the dialog below is displayed. Click **Yes**.

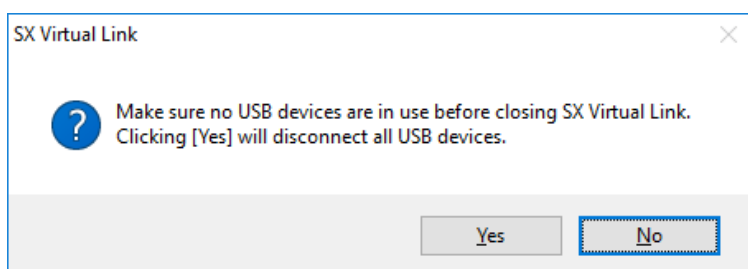

- Clicking **Yes** will disconnect all USB devices. Check that no USB devices are in use before finishing SX Virtual Link.

7-1-4. Online Help

SX Virtual Link has an Online Help which provides helpful information on its usage. How to access the Online Help is as follows:

1. Start SX Virtual Link.
2. In SX Virtual Link's main window, click the **Help** button () and select **Help** from the menu displayed.

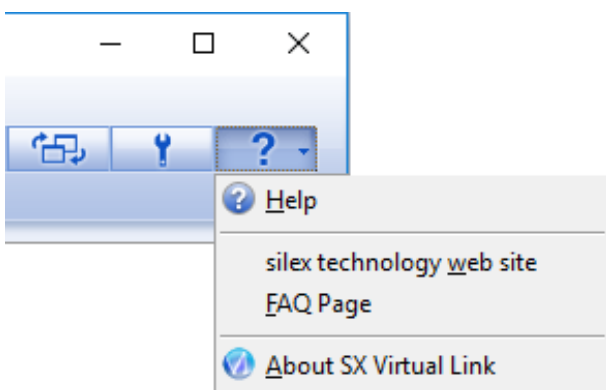

3. Online Help will open.

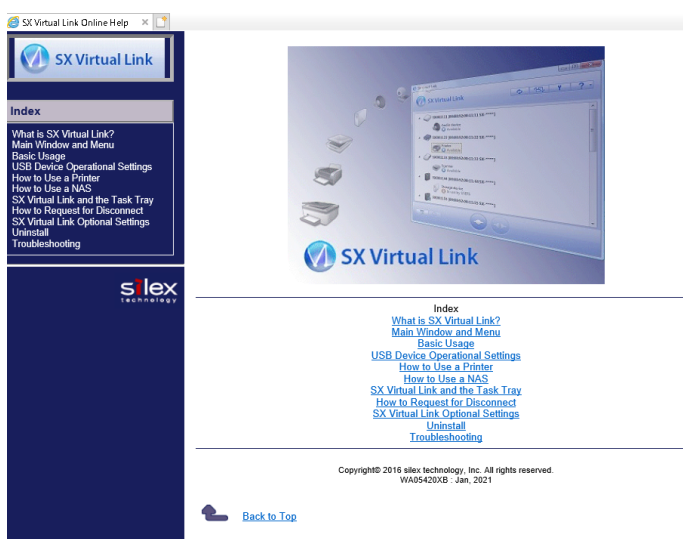

Blank page

8. Other Features

8-1. Using the Web Configuration Page

This page explains how to configure advanced settings using a Web browser.

Since DS-700AC has the HTTP protocol, advanced settings can be configured or changed via a Web browser. Useful functions such as a remote restart or status monitor are available.



- To use a Web browser, the TCP/IP settings need to be enabled, and an IP address needs to be configured.
- We recommend the following Web browsers:

Internet Explorer11 / Microsoft Edge / Safari / Google Chrome

- In the following instructions, Internet Explorer 11 and Windows 10 are used as example. Display may vary depending on the Web browser.



Note

- The Web configuration page complies with HTTP 1.0(RFC1945) / HTML 3.0.
- The operating status of the connected USB device is automatically refreshed in every 30 sec.

8-1-1. Displaying the Web page of DS-700AC

Displaying the Web page of DS-700AC

There are 2 ways to display the Web page described below.

Using SX Virtual Link to display the Web page

Follow the instructions below to display the Web page using SX Virtual Link.

1. From the SX Virtual Link's main window, select the USB device and click the Properties button ()

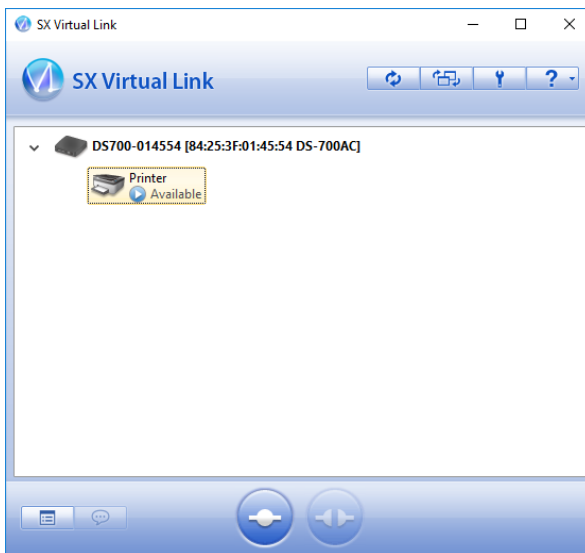

2. In the Properties dialog, the **General** tab is displayed. Click **Device Server Properties** button.

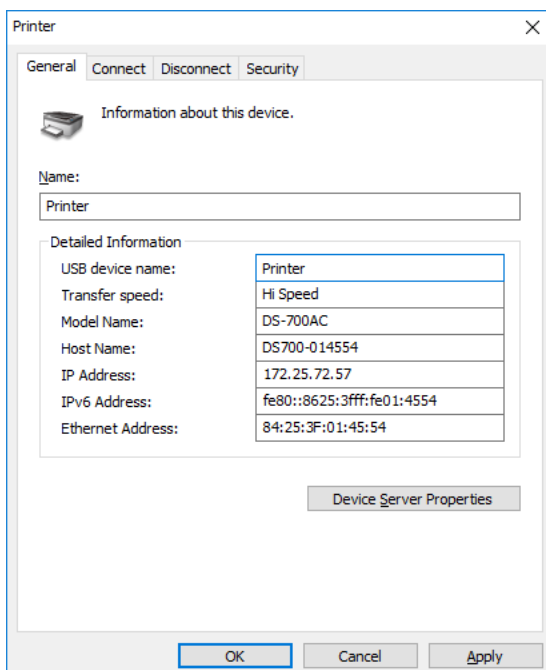

3. The Web browser will run and the login password configuration page will be displayed. Enter the password to configure for DS-700AC and click **Submit**.

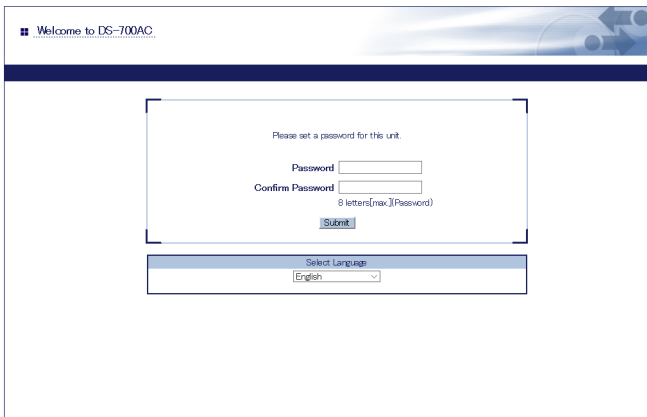

The screenshot shows a web browser window with the title "Welcome to DS-700AC". The main content area contains a form with the following elements:

- A heading: "Please set a password for this unit."
- A "Password" input field.
- A "Confirm Password" input field with a note below it: "8 letters(max.)Password".
- A "Submit" button.
- A "Select Language" dropdown menu with "English" selected.



Note

- When the login password is already configured, this page is not displayed.

4. The login page is displayed. Enter the password you have configured for DS-700AC and click **Login**.

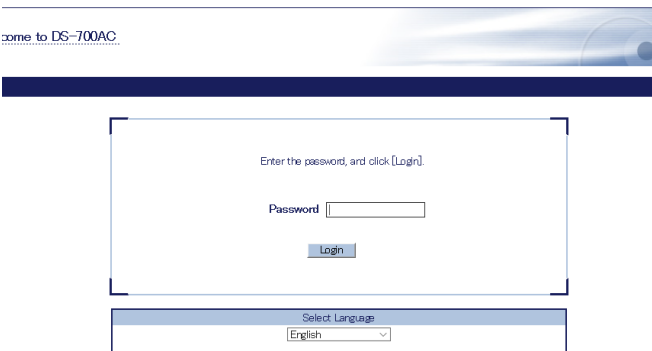

The screenshot shows a web browser window with the title "Welcome to DS-700AC". The main content area contains a form with the following elements:

- A heading: "Enter the password, and click [Login]."
- A "Password" input field.
- A "Login" button.
- A "Select Language" dropdown menu with "English" selected.

Using a Web browser to display the Web page

1. Enter the IP address that is configured on DS-700AC in the address bar of the Web browser. Press the ENTER key.

Example) Enter 172.25.72.57 and press the ENTER key.



2. The Web browser will run and the login password configuration page will be displayed. Enter the password to configure for DS-700AC and click **Submit**.

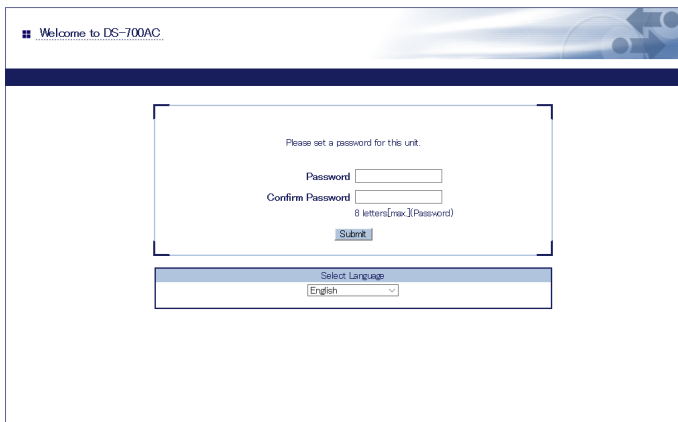

- When the login password is already configured, this page is not displayed.

Note

3. The login page is displayed. Enter the password you have configured for DS-700AC and click **Login**.

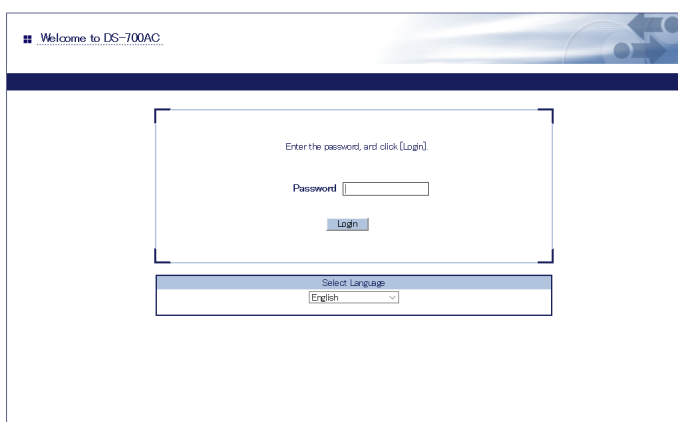

About each page

Status	Shows the operating status of USB device and DS-700AC.
Network Conf.	Configures the network settings of DS-700AC.
Security	Configures the access control for DS-700AC.
Maintenance	Provides the initialization, reboot and firmware update.



- By clicking **Languages**, you can switch the language among Japanese, English.

Note

8-1-2. Status Information

This page explains the status information page.

Status Information page shows the operating status of DS-700AC and the USB devices connected to it.

USB Device Status

Device status page shows the operating status of the USB device connected to DS-700AC.

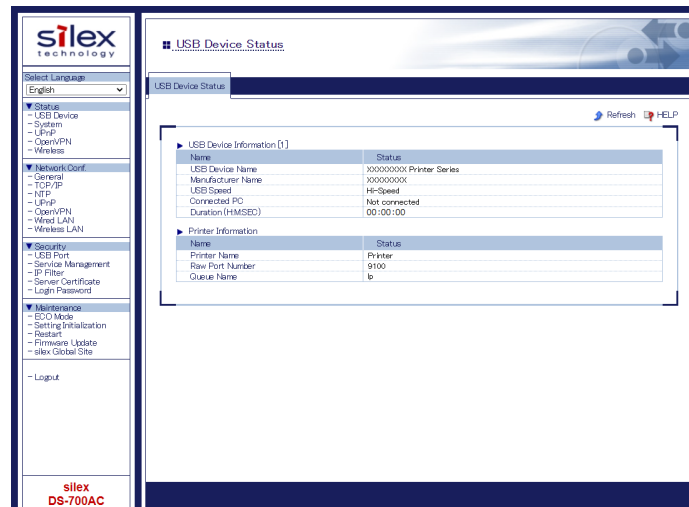

<USB Device Information [x] > (*This shows as many information items as the number of connected USB devices.)

Name	Details
USB Device	Displays the name of the USB device. If the device name cannot be obtained, it is displayed as ProductID(PID[0xXXXX]).
Manufacturer Name	Displays the manufacturer name of the USB device. If the manufacturer name cannot be obtained, it is displayed as VendorID(VID[0xXXXX]).
USB Speed	Displays the bus data transfer rate of the USB device. (Super-Speed, Hi-Speed, Full-Speed, Low-Speed)
Connected PC	Displays the IP address of PC (host) that uses the USB device. If the USB device is not connected to a PC, it is displayed as "Not Connected".
Duration (H:M:SEC)	Displays the period of time since the USB device is connected to PC.

<Printer Information>

Name	Details
Printer Name	Displays the name of the printer. If the printer name cannot be obtained, it is displayed as ProductID(PID[0xXXXX]).
Raw Port No.	Displays the TCP port number for RAW mode printing with this printer.
Queue Name	Displays the queue name for LPR printing with this printer.

System Status

System status page shows the operating status of DS-700AC.



<System Status>

Name	Details
Series Name	Displays a series name of DS-700AC.
Product Name	Displays the product name.
Version	Displays the version of DS-700AC.
MAC Address	Displays the MAC Address of DS-700AC.
Host Name	Displays the host name.

<TCP/IP Status>

Name	Details
IP Address	Displays the IP address. When Network Mode is WIRELESS , the information for both wireless LAN and wired LAN is displayed.
Subnet Mask	Displays the subnet mask. When Network Mode is WIRELESS , the information for both wireless LAN and wired LAN is displayed.
Default Gateway	Displays the default gateway.
Extended Segment	Shows the extended segment. This is displayed when Network Mode is WIRELESS and Wired LAN Operation is ENABLE .
Extended Subnet Mask	Shows the extended subnet mask. This is displayed when Network Mode is WIRELESS and Wired LAN Operation is ENABLE .
Extended Gateway	Shows the extended gateway. This is displayed when Network Mode is WIRELESS and Wired LAN Operation is ENABLE .
DNS Server (Primary)	Displays the primary DNS server.
DNS Server (Secondary)	Displays the secondary DNS server.
DHCP Server	Displays the address of the DHCP server from which the IP address was obtained. (This information is displayed only when the IP address was obtained from a DHCP server.)
WINS Server	Displays the WINS server. (This information is displayed only when the WINS server is set.)
IPv6 Address	Displays the IPv6 address. When Network Mode is WIRELESS , the information for both wireless LAN and wired LAN is displayed.
IPv6 Router	Displays the IPv6 router.

UPnP Status

UPnP Status page displays the IGD operating status obtained by UPnP.

The screenshot shows the UPnP Status page with the following sections:

- IGD Status:**

Name	Status
External IP	192.168.1.195
- IGD Register Information:**

Name	External Port	Protocol	Destination	Description
Server Search	19540	UDP	192.168.1.195:19540	DS700-015CE7
Server Connect	19540	TCP	192.168.1.195:19540	DS700-015CE7
- IGD Port Forwarding List:**

Name	External Port	Protocol	Destination	Description
ID1	19540	UDP	192.168.1.195:19540	DS700-015CE7
ID2	19540	TCP	192.168.1.195:19540	DS700-015CE7

< IGD Status >

Name	Details
External IP	Displays the IGD external IP address.

< IGD Register Information >

Name	Details
Server Search	Displays the port forwarding setting registered to IGD to search for DS-700AC.
Server Connect	Displays the port forwarding setting registered to IGD to connect the USB device.

< IGD Port Forwarding List >

Name	Details
IDx	Displays all port forwarding settings obtained from IGD. * This shows as many information items as the number of rules registered to IGD.

OpenVPN Status

OpenVPN Status page displays the VPN connection status and IP Address.

The screenshot shows the OpenVPN Status page with the following data:

Name	Status
Connect Status	Disconnect
IP Address	-
Log	<pre> 1970-01-01 08:00:50 [SYSTEM DATE] 1970-01-01 08:00:32 Could not determine IPv4/IPv6 protocol 1970-01-01 08:00:32 SIGUSR1 [auth_instance] received, process restarting 1970-01-01 08:00:32 Restart pause, 10 second(s) 1970-01-01 08:00:42 Outgoing Control Channel Authentication: Using 256 bit message hash SHA256 for HMAC authentication 1970-01-01 08:00:42 Incoming Control Channel Authentication: Using 256 bit message hash SHA256 for HMAC authentication 1970-01-01 08:00:42 RESOLVE: Cannot resolve host address: azure.gateway-2800006e-123d-45b4-9471-3a322b438ed3-3500b79426a4-vpn.azure.com:443 (Temporary failure in name resolution) 1970-01-01 08:00:42 RESOLVE: Cannot resolve host address: azure.gateway-2800006e-123d-45b4-9471-3a322b438ed3-3500b79426a4-vpn.azure.com:443 (Temporary failure in name resolution) 1970-01-01 08:00:42 Could not determine IPv4/IPv6 protocol 1970-01-01 08:00:42 SIGUSR1 [auth_instance] received, process restarting 1970-01-01 08:00:42 Restart pause, 20 second(s) </pre>

< OpenVPN Status >

Name	Details
Connect Status	Displays the VPN connection status.
IP Address	Displays the VPN IP address.
Log	Displays the newest VPN log and the system time.

Wireless Status

System status page shows the operating status of DS-700AC.

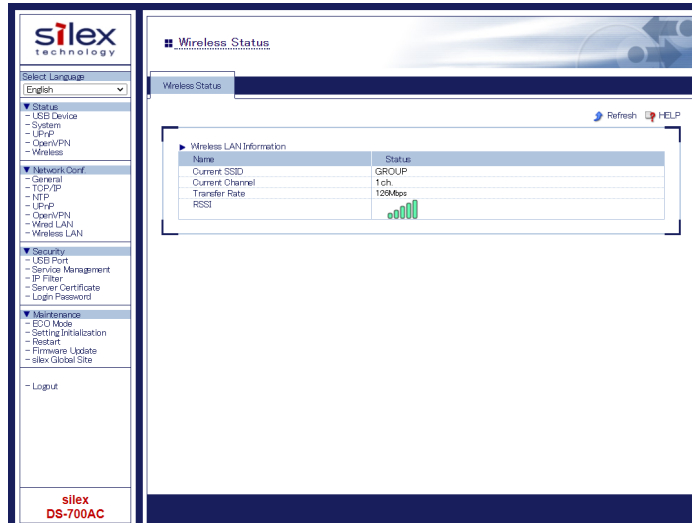

< Wireless LAN Information >

Name	Details
Current SSID	Displays the current SSID.
Current Channel	Displays the current channel.
Transfer Rate	Displays the wireless transmission rate.
RSSI	Displays the wireless signal strength with an antenna image.

8-1-3. Network Settings

This page explains the network settings of DS-700AC.

General Configuration

General Configuration page provides the host name and workgroup settings.

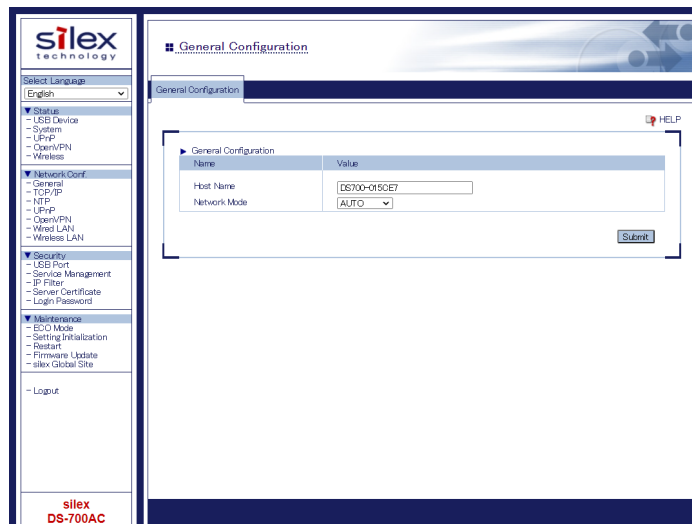

< General Configuration >

Name	Details	Default
Host Name	Set the host name. The host name is used for SX Virtual Link, WINS, etc. Be sure to use a unique name that is not used by other devices.	DS700-xxxxxx (xxxxxx is the last 6 digits of the MAC address)
Network Mode	Select the type of network connection. - AUTO Automatically detects the connection type. If a network cable is connected at the time of power on, DS-700AC will be connected to a wired network. Otherwise, DS-700AC will be connected to a wireless network. - WIRELESS Connects to a wireless network. - WIRED Connects to a wired network via a network cable.	AUTO

TCP/IP Configuration

TCP/IP Configuration page provides the IP address setting.

When **Network Mode** is **WIRELESS** :

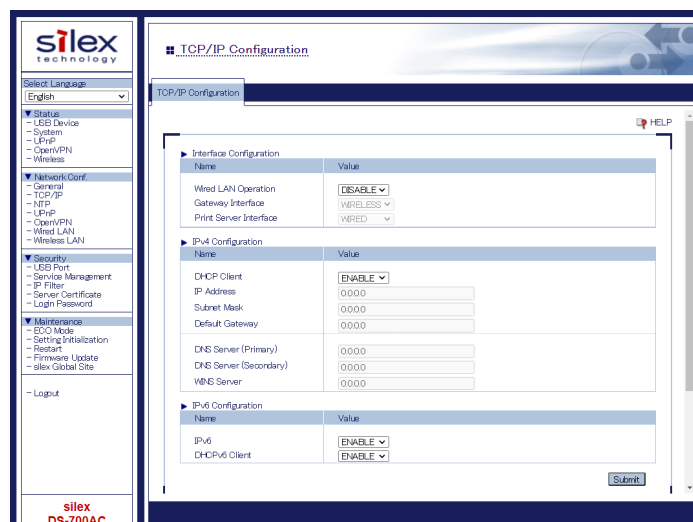

< Interface Configuration >

Name	Details	Default
Wired LAN Operation	Enable/Disable the simultaneous operation of wireless LAN and wired LAN. This is displayed when Network Mode is WIRELESS .	DISABLE
Gateway Interface	Select an interface to use for the gateway when the simultaneous operation of wireless LAN and wired LAN is enabled. The following settings are valid only for the interface selected for the gateway interface. - DHCPv6 Client - Default Gateway	WIRELESS
Print Server Interface	Select the interface to use the print server function when Wired LAN Operation is ENABLE .	WIRED

< IPv4 Configuration >

Name	Details	Default
DHCP Client	Enable/Disable the DHCP client function. To assign an IP address using DHCP, the DHCP server must be running in your subnetwork. When Wired LAN Operation is ENABLE , the information for both wireless LAN and wired LAN is displayed, however, the setting will be valid only on the interface selected at Gateway Interface .	ENABLE

IP Address	Set an IP address. When DHCP is enabled, an IP address obtained from it will be given higher priority. When Wired LAN Operation is ENABLE , the information for both wireless LAN and wired LAN is displayed.	0.0.0.0
Subnet Mask	Set a subnet mask. When set to "0.0.0.0", a subnet mask appropriate for the IP address is automatically used. When DHCP is enabled, a subnet mask obtained from it will be given higher priority. When Wired LAN Operation is ENABLE , the information for both wireless LAN and wired LAN is displayed.	0.0.0.0
Default Gateway	Set a gateway address. If "0.0.0.0" is set, this setting is disabled. When DHCP is enabled, a default gateway address obtained from it will be given higher priority.	0.0.0.0
Extended Segment	Add a network segment to communicate with devices of a different network segment via the selected interface. This function is set for the interface that is not selected as a gateway interface. This is displayed when Wired LAN Operation is ENABLE .	0.0.0.0
Extended Subnet Mask	Set a subnet mask for the extended segment. This is displayed when Wired LAN Operation is ENABLE .	0.0.0.0
Extended Gateway	Set an IP address of the gateway to communicate with devices of the extended segment. This is displayed when Wired LAN Operation is ENABLE .	0.0.0.0
DNS Server (Primary)	Set a primary DNS server address. When DHCP is enabled, the DNS address obtained from it will be given higher priority.	0.0.0.0
DNS Server (Secondary)	Set a secondary DNS server address. When DHCP is enabled, the DNS address obtained from it will be given higher priority.	0.0.0.0
WINS Server	Set a WINS server address. When DHCP is enabled, the WINS server address obtained from it will be given higher priority.	0.0.0.0

< IPv6 Configuration >

Name	Details	Default
IPv6	Enable/Disable the IPv6 address. If this setting is enabled, IPv6 communication can be established when IPv6 address is automatically obtained. When Wired LAN Operation is ENABLE , the information for both wireless LAN and wired LAN is displayed.	ENABLE
DHCPv6 Client	Enable/Disable the DHCPv6 client function. If this setting is enabled, the network setting will automatically be obtained from the DHCPv6 server. When Wired LAN Operation is ENABLE , the information for both wireless LAN and wired LAN is displayed, however, the setting will be valid only on the interface selected at Gateway Interface .	ENABLE

When **Network Mode** is other than **WIRELESS** :

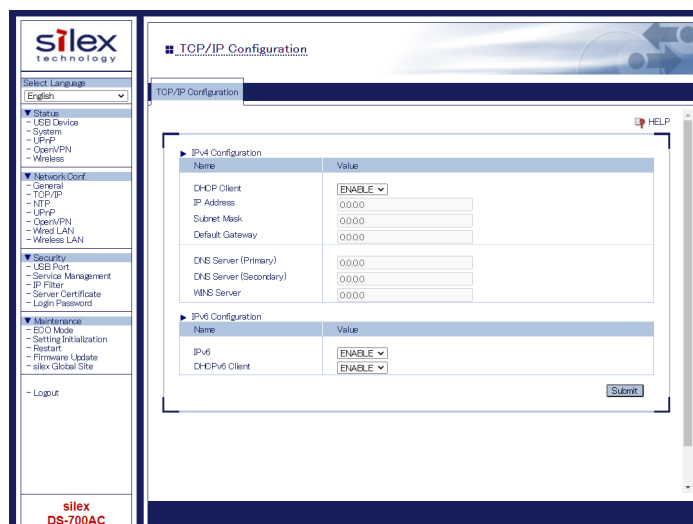

<IPv4 Configuration>

Name	Details	Default
DHCP Client	Enable/Disable the DHCP client function. To assign an IP address using DHCP, the DHCP server must be running in your subnetwork.	ENABLE
IP Address	Set an IP address. When DHCP is enabled, an IP address obtained from it will be given higher priority.	0.0.0.0
Subnet Mask	Set a subnet mask. When set to "0.0.0.0", a subnet mask appropriate for the IP address is automatically used. When DHCP is enabled, a subnet mask obtained from it will be given higher priority.	0.0.0.0
Default Gateway	Set a gateway address. If "0.0.0.0" is set, this setting is disabled. When DHCP is enabled, a default gateway address obtained from it will be given higher priority.	0.0.0.0
DNS Server (Primary)	Set a primary DNS server address. When DHCP is enabled, the DNS address obtained from it will be given higher priority.	0.0.0.0
DNS Server (Secondary)	Set a secondary DNS server address. When DHCP is enabled, the DNS address obtained from it will be given higher priority.	0.0.0.0
WINS Server	Set a WINS server address. When DHCP is enabled, the WINS server address obtained from it will be given higher priority.	0.0.0.0

<IPv6 Configuration>

Name	Details	Default
IPv6	Enable/Disable the IPv6 address. If this setting is enabled, IPv6 communication can be established when IPv6 address is automatically obtained.	ENABLE
DHCPv6 Client	Enable/Disable the DHCPv6 client function. If this setting is enabled, the network setting will automatically be obtained from the DHCPv6 server.	ENABLE

NTP Configuration

NTP Configuration page provides the NTP functional setting.

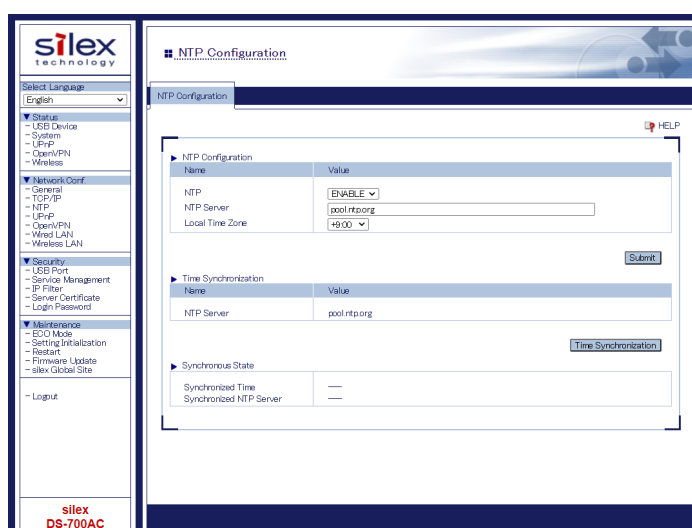
**<NTP Configuration>**

Name	Details	Default
NTP	Enable/Disable the NTP protocols.	ENABLE
NTP Server	Set the host name or IP Address for NTP server.	pool.ntp.org
Local Time Zone	Set Local Time Zone this product.	+9:00

<Time Synchronization> (* Displayed when the NTP setting is enabled.)

Name	Details	Default
NTP Server	Displays the name of NTP server to synchronize from. This product can be synchronized to the server configured for NTP Server at NTP Configuration.	pool.ntp.org

<Synchronous State> (* Displayed when the NTP setting is enabled.)

Name	Details	Default
Synchronized Time	Displays the time retrieved from the NTP server.	-----
Synchronized NTP Server	Displays the name of synchronized NTP server used to retrieve a time.	-----

UPnP Configuration

UPnP Configuration page provides the UPnP functional settings.

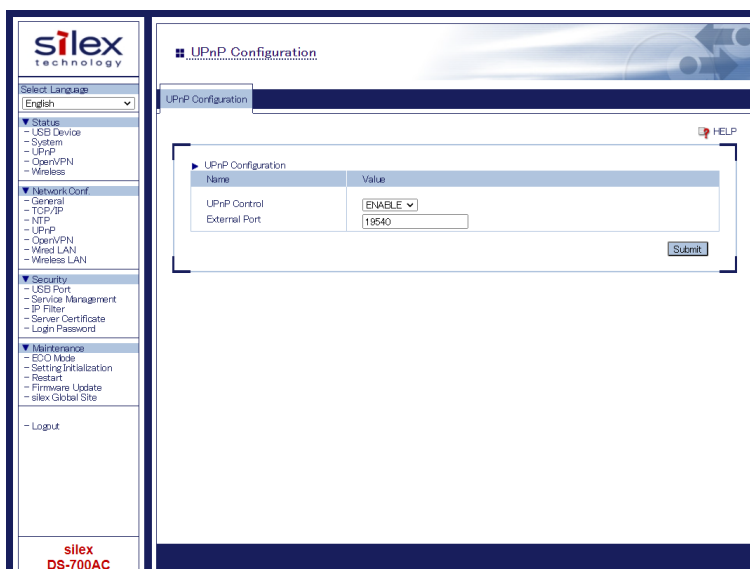

< UPnP Configuration >

Name	Details	Default
UPnP Control	Enable/Disable a function to set port forwarding to IGD over UPnP.	ENABLE
External Port	Set an external port number to configure for IGD. This port number is used for port forwarding. The same port number is used for UDP(Server Search) and TCP(Server Connect).	19540

OpenVPN Configuration

OpenVPN Configuration page provides the OpenVPN functional settings.

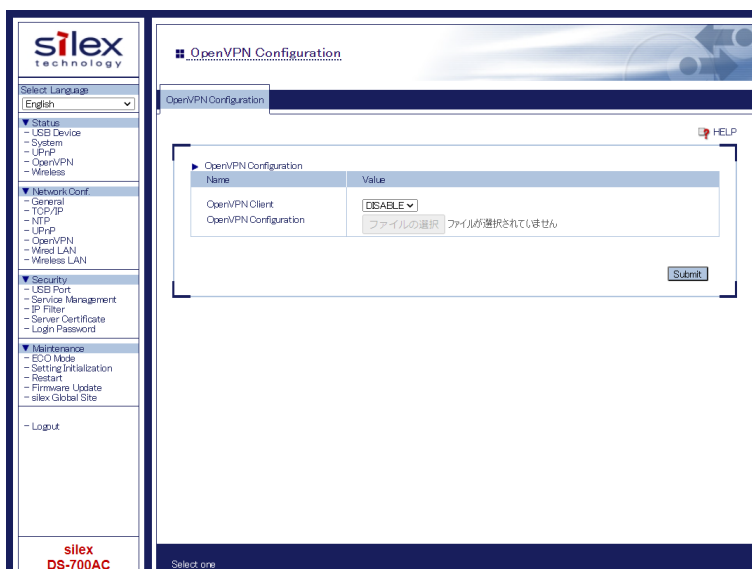

< OpenVPN Configuration >

Name	Details	Default
OpenVPN Client	Enable/Disable the OpenVPN client function.	DISABLE
OpenVPN Configuration	Import an OpenVPN client configuration file(*.ovpn).	None

< Registration Status > (* Displayed when the OpenVPN Client is enabled.)

Name	Details
OpenVPN Configuration	Shows the information of connection destination.

Wired LAN Configuration

Wired LAN Configuration page provides the link speed setting.

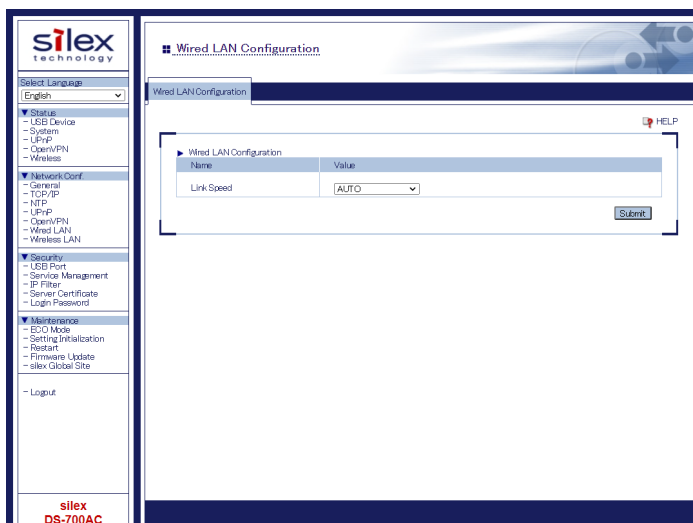

< Wired LAN Configuration >

Name	Details	Default
Link Speed	<p>Select the physical network type (AUTO / 10BASE-T-Half / 10BASE-T-Full/ 100BASE-TX-Half / 100BASE-TX-Full).</p> <p>In most cases, AUTO is used.</p> <p>If the LINK lamp on your HUB does not light up when this product is turned on, configure this setting to match that of the HUB.</p>	AUTO

Wireless LAN Configuration

Wireless LAN Configuration page provides the wireless settings to connect to Access Points. This page is composed of **Easy Configuration**, **Detailed Configuration** and **Smart Wireless Setup** tabs.

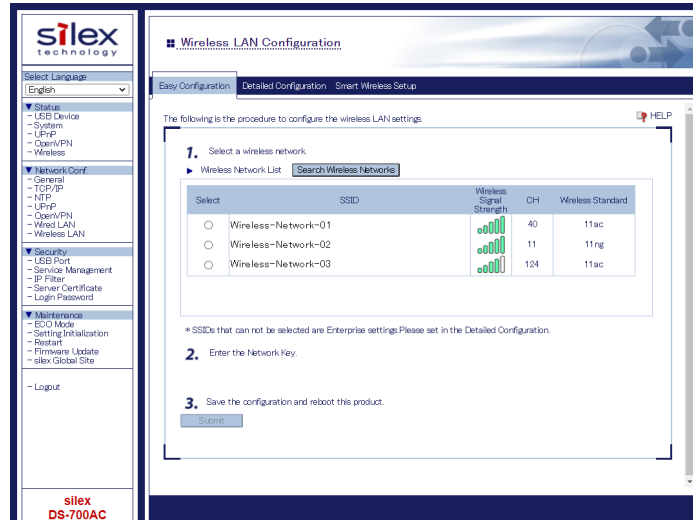

For details on each tab, see below table

Name	Details
Easy Configuration	Searches for wireless networks and shows the result in the Web page. Wireless configuration can be done by selecting Access Point from a list and entering WEP Key or Pre-Shared Key for network key.
Detailed Configuration	Users can manually configure the necessary wireless settings.
Smart Wireless Setup	Provides the Smart Wireless Setup that can configure DS-700AC using 8-digit PIN code. In this page, PIN code can be updated and Smart Wireless Setup can be executed using the PIN code.



Note

- For details on the wireless LAN configuration above, refer to **8-3. Wireless Configuration on Web Configuration Page**.

8-2. About the Print Server Feature

8-2-1. About the Print Server Feature

This page explains the print server feature.

The print server feature uses network printing protocols to allow you to print over the network.

DS-700AC supports the common network printing protocols, "Raw" and "LPR".
When a printer is connected to DS-700AC, standard Windows printing can be used.

Please note that you do not have to use SX Virtual Link for printing via the print server feature.



- When standard Windows printing is used, it is impossible to get printer status using the status monitor software that came with the printer or MFP.
Also, if the printer supports a-directional printing only, standard Windows printing cannot be used.
- When using standard Windows printing, only 1 printer can be used at a time. To connect 2 or more printers, SX Virtual Link must be used.
For how to connect 2 or more printers, refer to **9-1. Useful Information - How can I use two or more USB devices?**
- It is impossible to print to printers or MFPs connected to other PCs via SX Virtual Link.
Also, when printers or MFPs are busy with standard Windows printing, they cannot be connected via SX Virtual Link.

8-2-2. Before Using Standard Windows Printing

This page explains how to configure the settings to print using standard Windows printing.

Before adding a printer port, access the Web page of DS-700AC and check the destination printer port assigned to the printer connected to DS-700AC.



[STEP 1]	[STEP 2]	[STEP 3]
Select a printing protocol	Take notes of the destination printer port	Add a printer port
Raw mode printing	Take notes of the Raw Port No. assigned to the printer.	Print using the Raw port of Windows 7 or newer.
LPR printing	Take notes of the Queue Name assigned to the printer.	Print using the LPR port of Windows 7 / 8 / 8.1 / 10 or newer.



Note

- Refer to **8-1-1. Displaying the Web page of DS-700AC** to access DS-700AC using a Web browser.

8-2-3. Printing Using the LPR Port on Windows 7

This page explains how to configure the settings to print on Windows 7 using the standard LPR port.



- When standard Windows printing is used, it is impossible to get printer status using the status monitor software that came with the printer or MFP. Also, if the printer supports bi-directional printing only, standard Windows printing cannot be used.
- When using standard Windows printing, only 1 printer can be used at a time. To connect 2 or more printers, SX Virtual Link must be used. For how to connect 2 or more printers, refer to **9-1. Useful Information - How can I use two or more USB devices?**
- It is impossible to print to printers or MFPs connected to other PCs via SX Virtual Link. Also, when printers or MFPs are busy with standard Windows printing, they cannot be connected via SX Virtual Link.

1. Click **Start - Control Panel - View devices and printers - Add a printer.**

2. The wizard for adding a printer appears. Click **Add a network, wireless or Bluetooth printer.**

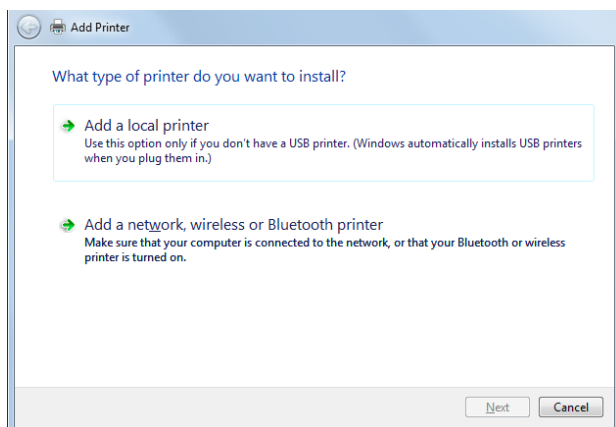

3. Click **The printer that I want isn't listed.**

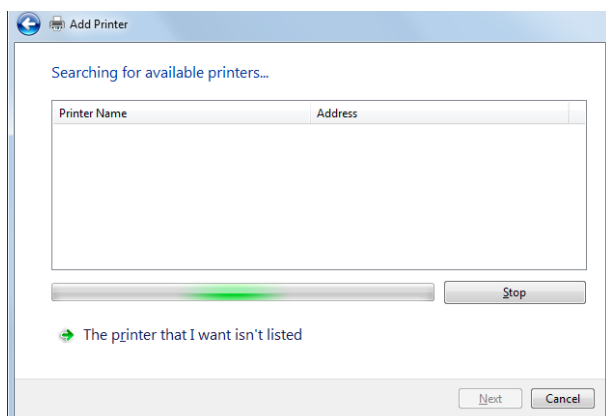

4. Select the method to add a printer.
Click **Add a printer using a TCP/IP address or hostname** and click **Next**.

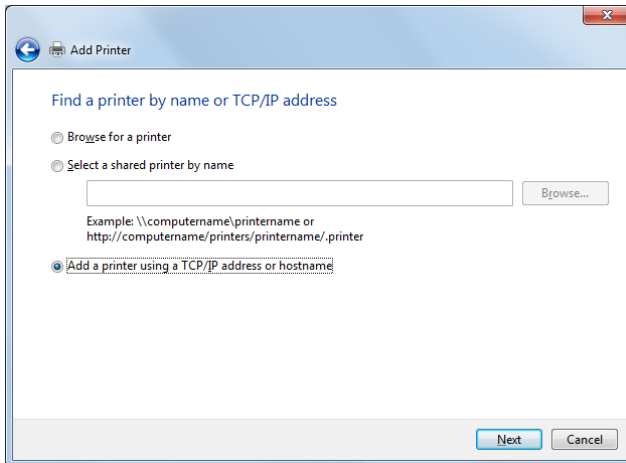

5. Select **TCP/IP Device** for **Device type** and enter the IP address assigned to DS-700AC for **Hostname or IP address**.
Clear **Query the printer and automatically select the driver to use** check box and click **Next**.

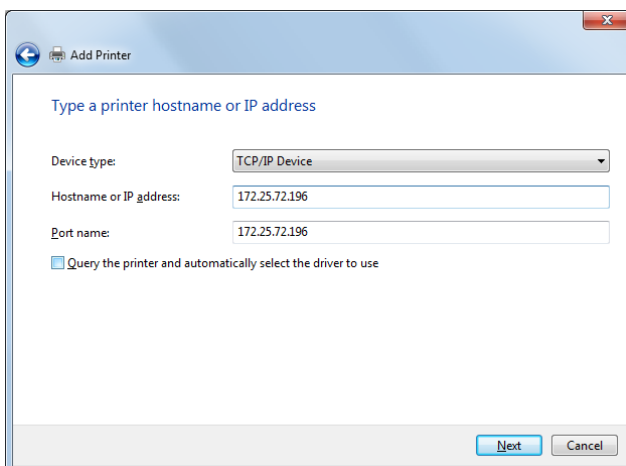

Note

- In most cases, the default port name is used. If you wish to change the port name, enter a unique name that is not used for other ports.

6. Select a printer driver.
Select the printer driver you want to use and click **Next**.

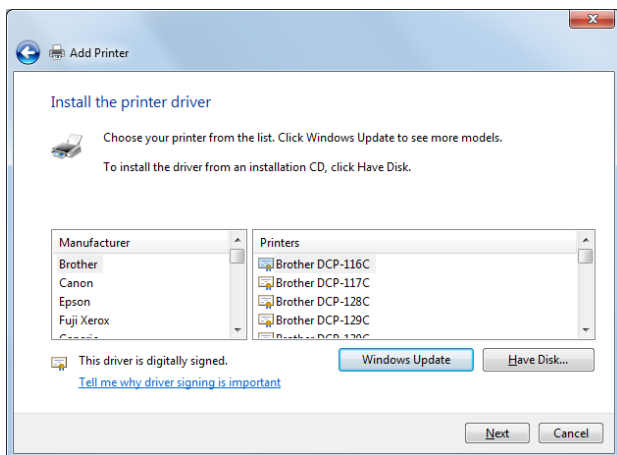

7. Enter a printer name and click **Next**.

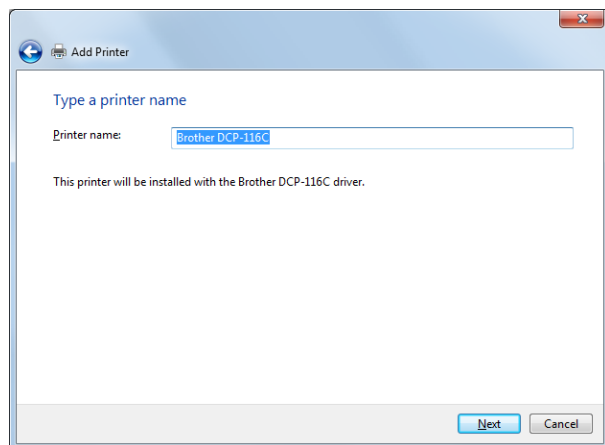

8. Click **Print a test page** and see the result of printing. If the print result is OK, click **Finish**.
The print setting has been completed.

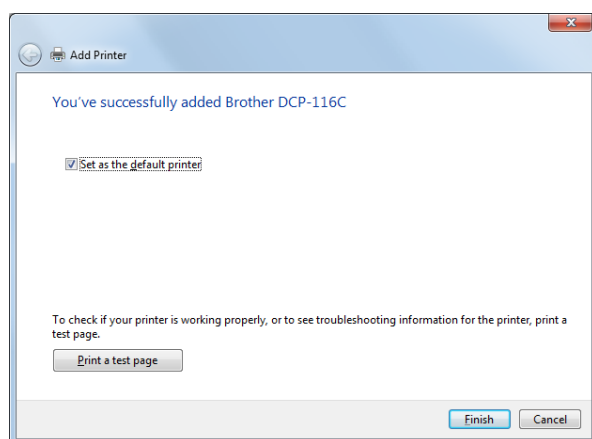

- If you are going to use the Raw port printing, click **Finish** without printing a test page.

Note

8-2-4. Printing Using the LPR Port on Windows 8/8.1/10 or Newer

This page explains how to configure the settings to print on Windows 8/8.1/10 or newer using the LPR port.



TIP

- When standard Windows printing is used, it is impossible to get printer status using the status monitor software that came with the printer or MFP.
Also, if the printer supports bi-directional printing only, standard Windows printing cannot be used.
- When using standard Windows printing, only one printer can be used at a time. To connect 2 or more printers, SX Virtual Link must be used.
- It is impossible to print to printers or MFPs connected to other PCs via SX Virtual Link.
Also, when printers or MFPs are busy with standard Windows printing, they cannot be connected via SX Virtual Link.
- In this page, sample screens captured from Windows 8.1 are used.

1. Click **Start - Control Panel - View devices and printers - Add a printer.**

2. Click **The printer that I want isn't listed.**

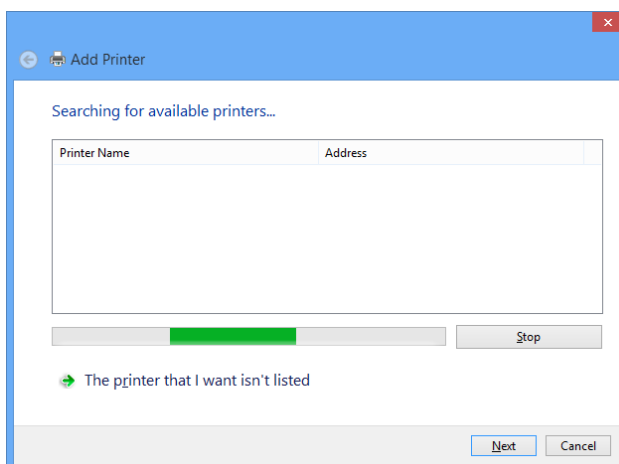

3. Select the method to add a printer.
Select **Add a printer using a TCP/IP address or hostname** and click **Next**.

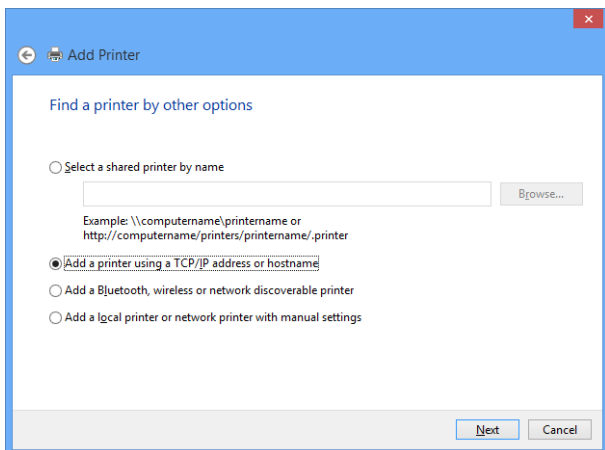

4. Select **TCP/IP Device** for **Device type** and enter the IP address assigned to DS-700AC for **Hostname or IP address**.
Clear **Query the printer and automatically select the driver to use** check box and click **Next**.

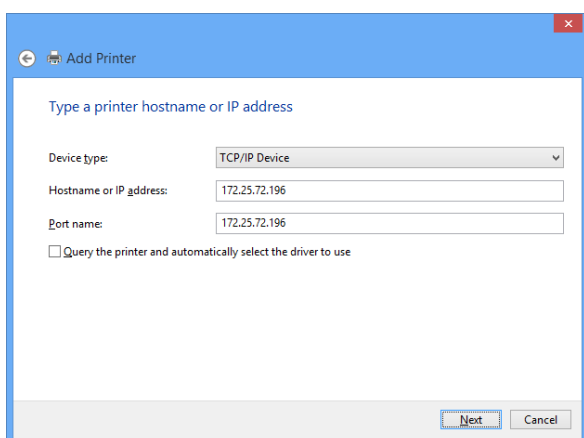

Note

- In most cases, the default port name is used. If you wish to change the port name, enter a unique name that is not used for other ports.

5. Select a printer driver.
Select the printer driver you want to use and click **Next**.

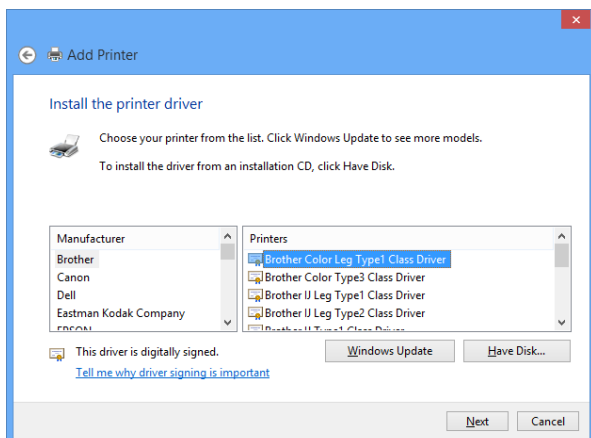

6. Enter a printer name and click **Next**.

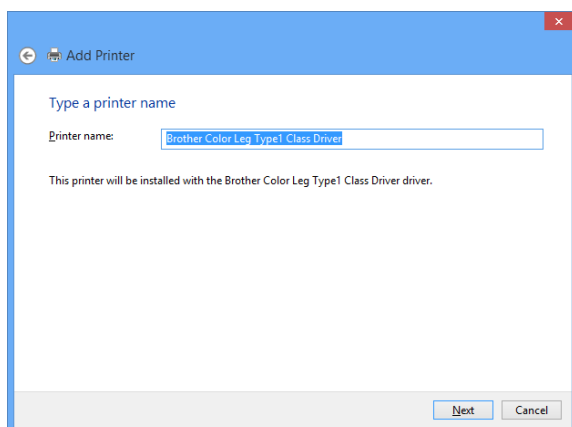

7. Click **Print a test page** and see the result of printing. If the print result is OK, click **Finish**. The print setting has been completed.

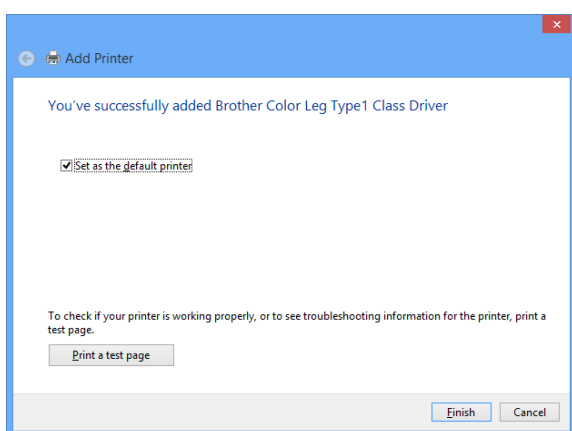
**Note**

- If you are going to use the Raw port printing, click **Finish** without printing a test page.

8-2-5. Printing Using the Raw Port on Windows 7 or Newer

This page explains how to configure the settings to print on Windows 7 or newer using the Raw port.



TIP

- When standard Windows printing is used, it is impossible to get printer status using the status monitor software that came with the printer or MFP.
Also, if the printer supports bi-directional printing only, standard Windows printing cannot be used.
- When using standard Windows printing, only one printer can be used at a time. To connect 2 or more printers, SX Virtual Link must be used.
- It is impossible to print to printers or MFPs connected to other PCs via SX Virtual Link.
Also, when printers or MFPs are busy with standard Windows printing, they cannot be connected via SX Virtual Link.
- In this page, sample screens captured from Windows 10 are used.

1. Create the standard Windows LPR port according to the instructions at **8-2-3. Printing Using the LPR Port on Windows 7** or **Printing Using the LPR Port on Windows 8/8.1/10 or Newer**.
2. Click **Start - Control Panel - View devices and printers**. Right-click on the printer you have added, and select **Printer properties**.

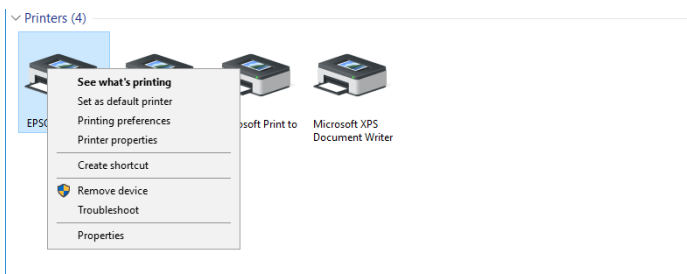

3. Click the **Port** tab, select the port that you have created, and click **Configure Port**.

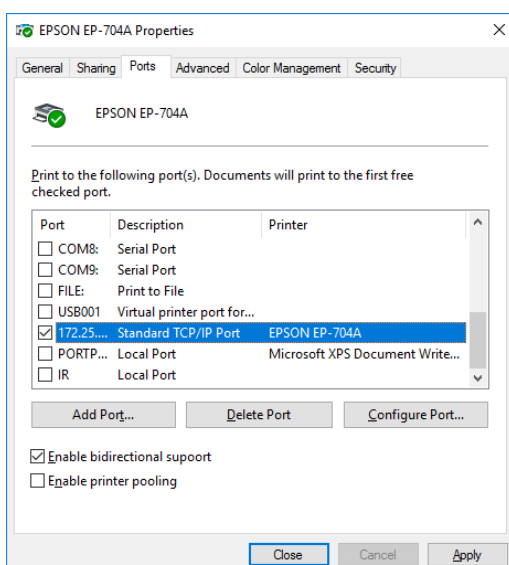

4. Select **Raw** for **Protocol**, enter the port number (the one displayed on the Web page) for **Port Number**, and click **OK**.

Configure Standard TCP/IP Port Monitor

Port Settings

Port Name: 172.25.73.228

Printer Name or IP Address: 172.25.73.228

Protocol

Raw LPR

Raw Settings

Port Number: 9100

LPR Settings

Queue Name: lp

LPR Byte Counting Enabled

SNMP Status Enabled

Community Name: public

SNMP Device Index: 1

OK Cancel

5. Click the **General** tab.
Click **Print Test Page**, confirm that the test print is output correctly, and click **OK**.

EPSON EP-704A Properties

General Sharing Ports Advanced Color Management Security

EPSON EP-704A

Location:

Comment:

Model: Epson ESC/P-R V4 Class Driver

Features

Color: Yes Paper available: Letter

Double-sided: Yes

Staple: No

Speed: Unknown

Maximum resolution: 360 dpi

Preferences... Print Test Page

Close Cancel Apply

8-3. Wireless Configuration on Web Configuration Page

8-3-1. Easy Wireless Configuration

This page explains how to configure the wireless settings by selecting the Access Point to connect.

1. Access the Web page of DS-700AC.



Note

- For how to display the Web page of DS-700AC, refer to **8-1-1. Displaying the Web page of DS-700AC.**

2. The login page is displayed.
Enter the password for DS-700AC and click **Login**.

Welcome to DS-700AC.

Enter the password, and click [Login].

Password

Select Language
English

3. The Web page of DS-700AC is displayed.
From the left menu on the Web page, click **Network Conf. - Wireless LAN**.

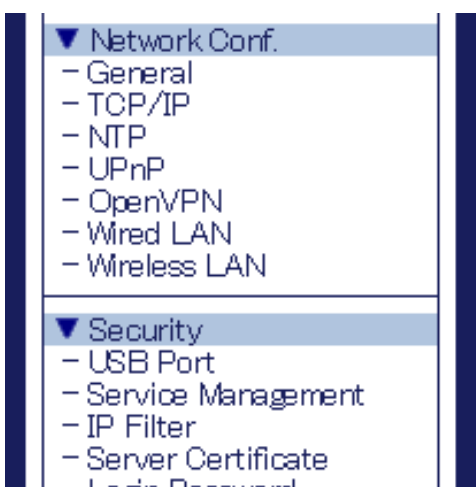

4. The Easy Configuration page is displayed.
Select the Access Point from **Wireless Network List** and enter WEP Key or Pre-Shared Key for **Network Key**.
Click **Submit** then.

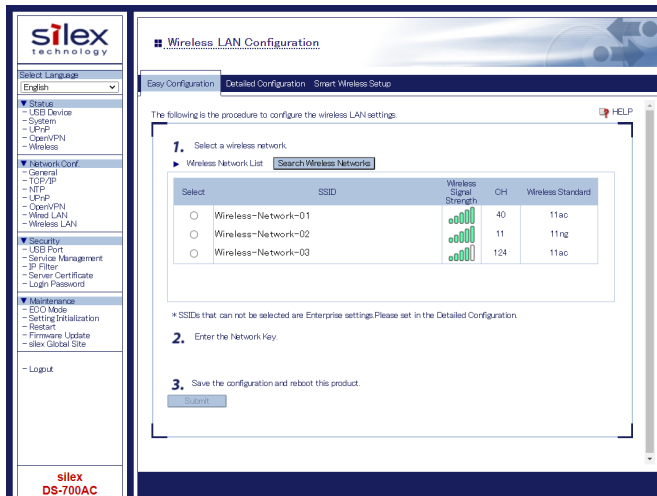

TIP

- In case of the followings, the wireless devices are not displayed in **Wireless Network List**. Click **Detailed Configuration** and configure the detailed wireless LAN setting then.
 - Access Points or wireless devices are set NOT to respond to wireless network search (stealth mode).
 - Access Points or wireless devices are in a remote location where radio waves cannot reach.
- WEP Key Index is set to 1.

5. The Restart page is displayed. Click **Restart** to restart DS-700AC.
The changes will take effect after restart.

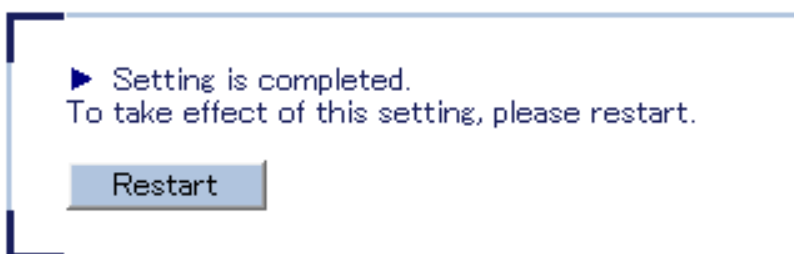

6. When the login page is displayed, the reboot is completed.
Finish the Web browser.

8-3-2. Detailed Wireless Configuration

This page explains how to configure the detailed wireless settings.

1. Access the Web page of DS-700AC.



Note

- For how to display the Web page of DS-700AC, refer to **8-1-1. Displaying the Web page of DS-700AC.**

2. The login page is displayed.
Enter the password for DS-700AC and click **Login**.

Welcome to DS-700AC.

Enter the password, and click [Login].

Password

[Login]

Select Language
English

3. The Web page of DS-700AC is displayed.
From the left menu on the Web page, click **Network Conf. - Wireless LAN**.

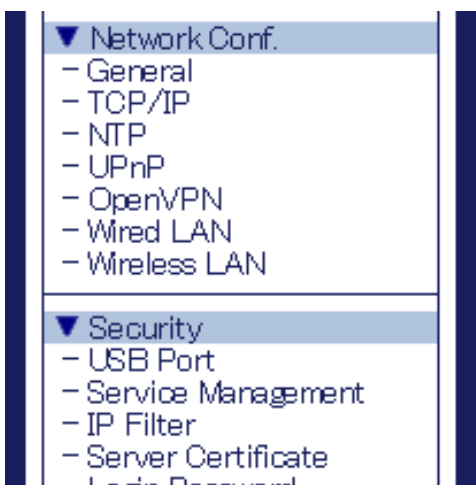

4. The Wireless LAN Configuration page is displayed. Click **Detailed Configuration** tab.

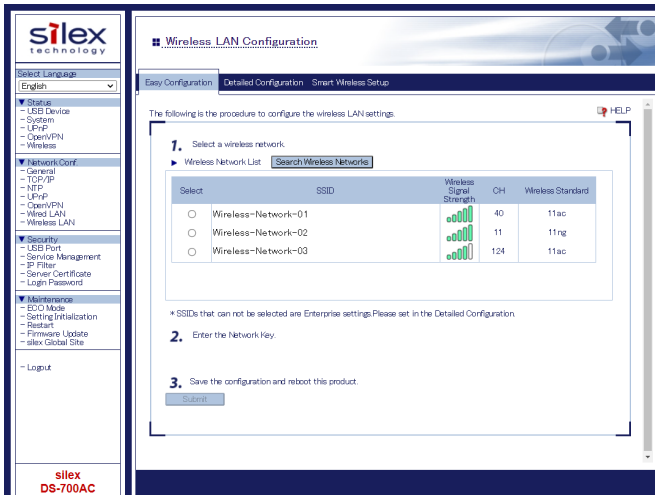

5. The detailed wireless configuration page is displayed. Configure each setting and click **Submit**.

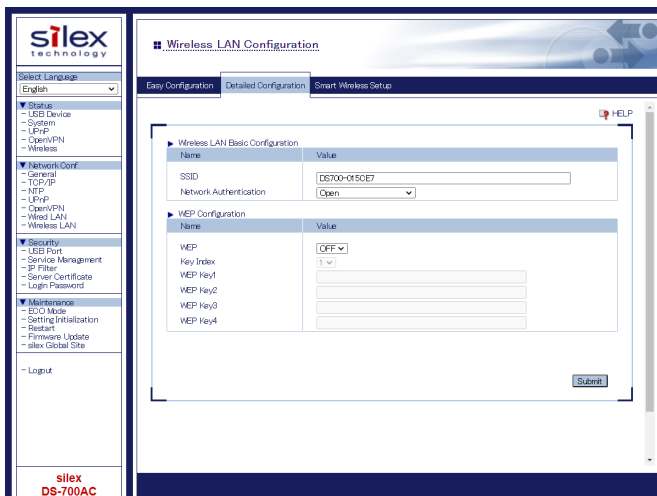

Detailed Configuration

Name	Details	Default Value
SSID	Set the SSID of your wireless network. The SSID is an ID that distinguishes a wireless LAN network from others. For wireless devices to communicate with each other on a wireless network, they must share the same SSID.	DS700-XXXXXX (XXXXXX is the last 6 digits of the Ethernet Address)

Network Authentication	<p>Select the network authentication mode that will be used to connect to wireless devices.</p> <p>Open (Open System): Allows all access without authentication. For encryption mode, WEP can be used.</p> <p>WPA2-Personal , WPA3-Personal: Uses PSK for network authentication. For encryption mode, AES can be used. The encryption key will be generated by communicating with a wireless device using Pre-Shared key. WEP key setting is not used for this mode.</p> <p>WPA/WPA2-Personal: Uses PSK for network authentication. For encryption mode, AUTO can be used. The encryption key will be generated by communicating with a wireless device using Pre-Shared key. WEP key setting is not used for this mode.</p> <p>WPA2-Enterprise , WPA3-Enterprise: Uses IEEE802.1X for network authentication. For encryption mode, AES can be used. Pre-Shared key and WEP key settings are not used for this mode.</p> <p>WPA/WPA2-Enterprise: Uses IEEE802.1X for network authentication. For encryption mode, AUTO can be used. Pre-Shared key and WEP key settings are not used for this mode.</p> <p>To ensure a secure network, it is recommended to use WPA/WPA2.</p>	Open
Encryption Mode	<p>The encryption mode is automatically selected for each network authentication mode.</p> <p>AES will be selected when the network authentication mode is WPA2-Personal / WPA3-Personal or WPA2-Enterprise / WPA3-Enterprise, and AUTO will be selected when the network authentication mode is WPA/WPA2-Personal or WPA/WPA2-Enterprise.</p>	AUTO

WEP

Name	Details	Default Value
WEP	Enable/Disable WEP encryption (ON/OFF). If WEP encryption is used, wireless communication will be encrypted using the settings for "WEP Key 1-4" and "Key Index".	OFF
Key Index	Select the number of the WEP key that you wish to use for encryption (1-4). This setting must be the same as that of your wireless device you wish to connect to.	1
WEP Key 1 - 4	Enter the WEP key in alphanumeric or hexadecimal characters. For alphanumeric characters, enter 5 characters when the key size is 64bit or 13 characters when the key size is 128bit. For hexadecimal, enter a 10-digit value when the key size is 64bit or a 26-digit value when the key size is 128bit.	None

WPA/WPA2-Personal/WPA3-Personal

Name	Details	Default Value
Pre-Shared Key	Set the Pre-Shared Key. This setting is necessary when AES/AUTO(*) is used for encryption mode. (*) WPA/WPA2-Personal support AUTO. The Pre-Shared Key is a keyword used to create the encryption key. It is also referred to as 'network key' or 'password'. In most cases, alphanumeric characters are used (8-63 characters). For Hexadecimal, a value consists of numbers (0-9) and English letters (A-F). WPA3-AES does not support 64 hexadecimal characters. This setting must be the same as that of the wireless device you wish to connect to.	12345678

WPA/WPA2-Enterprise/ WPA3-Enterprise

Name	Details	Default Value
Authentication Method	Set the EAP authentication method (EAP-TLS/EAP-TTLS/PEAP/EAP-FAST/LEAP).	EAP-TLS
EAP User Name	Set an EAP user name for the EAP authentication. This name is used by the server to identify a client.	None
EAP Password	Set an EAP password for the EAP authentication. This password is used to check client reliability when EAP-TTLS or PEAP or EAP-FAST or LEAP is used as authentication method.	None
Inner Authentication Method	Set the inner authentication method (PAP/CHAP/MSCHAP/MSCHAPv2) to perform in TLS tunneling of the EAP authentication. When PEAP is used as authentication method, this is fixed to MS-CHAPv2.	PAP
Client Certificate Password	Set a client certificate password to use for client authentication on the EAP authentication. This setting is necessary when a password is set to the client certificate	None
Client Certification	Select a client certificate to use for client authentication on the EAP authentication. This is used when EAP-TLS is used as authentication method.	None
Server Authentication	Specify whether to check reliability of the server on EAP authentication. When ON is selected, CA certificate for server authentication is required.	OFF
CA Certification	Select a CA certificate to use for server authentication on the EAP authentication. This setting is necessary when ON is selected for server authentication.	None
Auto PAC Provisioning	Enable/Disable auto-distribution of PAC (Protected Access Credential) when using EAP-FAST authentication (ON/OFF).	OFF
PAC File	Register the PAC file issued from the server to use for manual distribution of PAC (Protected Access Credential) when using EAP-FAST authentication.	None

6. The Restart page is displayed. Click **Restart** to restart DS-700AC. The changes will take effect after restart.

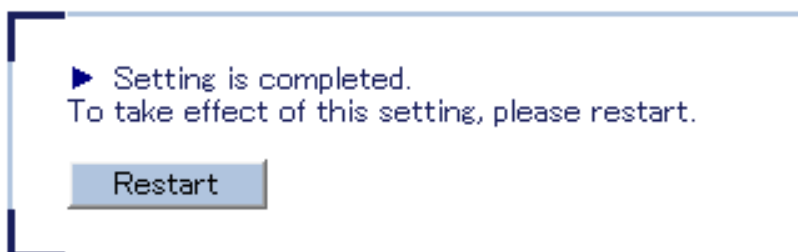

7. When the login page is displayed, the reboot is completed. Finish the Web browser.

8-3-3. IEEE802.1X Authentication

This page explains how to configure the settings to use IEEE802.1X authentication.

Supported 802.1X Authentication Methods

DS-700AC supports the following IEEE802.1X authentication methods.

- PEAP (PEAPv0)
- EAP-TLS
- EAP-TTLS
- LEAP
- EAP-FAST

Standard and Saving Format for Certificate

Standard for Certificate

DS-700AC supports the standard of certificate as follows:

Item	Compatible standards
Key exchange method	RSA
Key size	512bit, 1024bit, 2048bit
Signature algorithm	SHA1withRSA SHA224withRSA SHA256withRSA SHA384withRSA SHA512withRSA MD5withRSA

Saving Format for Certificate

DS-700AC supports the saving format of certificate as follows:

Item	Compatible standards
Client certificate	PKCS#12 PFX
CA certificate for server authentication	DER (Binary encoded X509) PEM (BASE64-encoded text format of DER)

IEEE 802.1X Settings

1. Access the Web page of DS-700AC.



Note

- For how to display the Web page of DS-700AC, refer to **8-1-1. Displaying the Web page of DS-700AC.**

2. The login page is displayed.
Enter the password for DS-700AC and click **Login**.

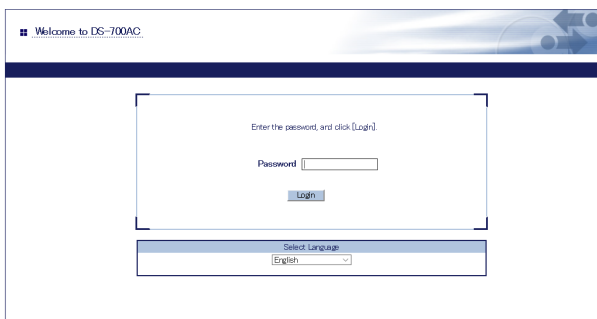

3. The Web page of DS-700AC is displayed.
From the left menu on the Web page, click **Network Conf. - Wireless LAN**.

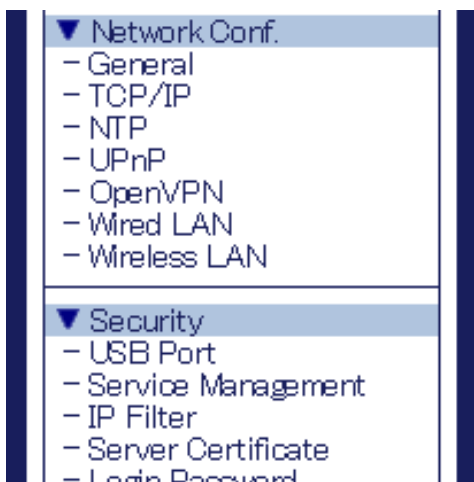

- The Wireless LAN Configuration page is displayed. Click **Detailed Configuration** tab.

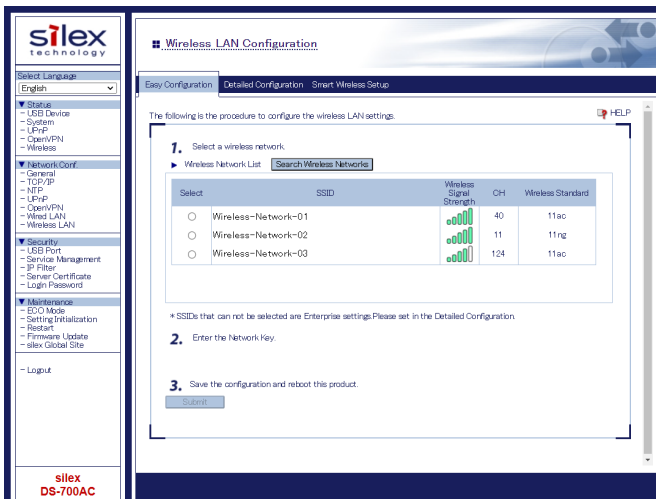

- The detailed wireless configuration page is displayed. Configure each setting and click **Submit**.

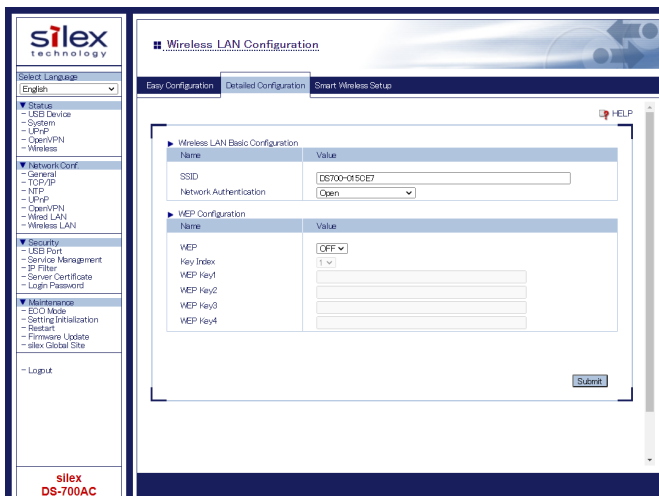

Name	Details	Default Value
Authentication Method	Set the EAP authentication method (EAP-TLS/EAP-TTLS/PEAP/EAP-FAST/LEAP).	EAP-TLS
EAP User Name	Set an EAP user name for the EAP authentication. This name is used by the server to identify a client.	None
EAP Password	Set an EAP password for the EAP authentication. This password is used to check client reliability when EAP-TTLS or PEAP or EAP-FAST or LEAP is used as authentication method.	None
Inner Authentication Method	Set the inner authentication method (PAP/CHAP/MSCHAP/MSCHAPv2) to perform in TLS tunneling of the EAP authentication. When PEAP is used as authentication method, this is fixed to MS-CHAPv2.	PAP
Client Certificate Password	Set a client certificate password to use for client authentication on the EAP authentication. This setting is necessary when a password is set to the client certificate	None
Client Certification	Select a client certificate to use for client authentication on the EAP authentication. This is used when EAP-TLS is used as authentication method.	None
Server Authentication	Specify whether to check reliability of the server on EAP authentication. When ON is selected, CA certificate for server authentication is required.	OFF
CA Certification	Select a CA certificate to use for server authentication on the EAP authentication. This setting is necessary when ON is selected for server authentication.	None
Auto PAC Provisioning	Enable/Disable auto-distribution of PAC (Protected Access Credential) when using EAP-FAST authentication (ON/OFF).	OFF
PAC File	Register the PAC file issued from the server to use for manual distribution of PAC (Protected Access Credential) when using EAP-FAST authentication.	None

Name	Authentication Method				
	PEAP	EAP-TLS	EAP-TTLS	LEAP	EAP-FAST
EAP User Name	Necessary	Necessary	Necessary	Necessary	Necessary
EAP Password	Necessary	--	Necessary	Necessary	Necessary
Inner Authentication Method	Necessary	--	Necessary	--	--
Client Certification	--	Necessary	--	--	--
Client Certificate Password	--	Optional	--	--	--
Server Authentication	Optional	Optional	Optional	--	--
CA Certification	Optional	Optional	Optional	--	--
Auto PAC Provisioning	--	--	--	--	Optional
PAC File	--	--	--	--	Optional

- The Restart page is displayed. Click **Restart** to restart DS-700AC. The changes will take effect after restart.

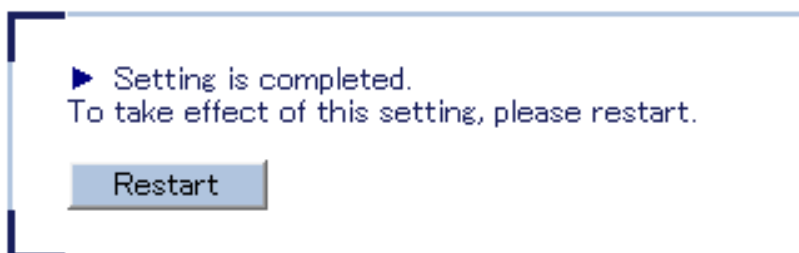

- When the login page is displayed, the reboot is completed. Finish the Web browser.

8-3-4. Smart Wireless Setup

This page explains the Smart Wireless Setup which can be used when your wireless router supports the WPS (Wi-Fi Protected Setup).

1. Access the Web page of DS-700AC.



Note

- For how to display the Web page of DS-700AC, refer to **8-1-1. Displaying the Web page of DS-700AC.**

2. The login page is displayed.
Enter the password for DS-700AC and click **Login**.

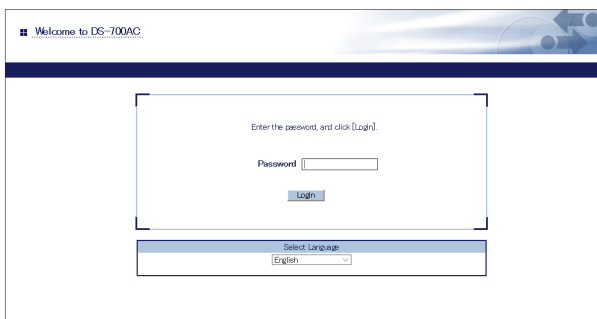

3. The Web page of DS-700AC is displayed.
From the left menu on the Web page, click **Network Conf. - Wireless LAN**.

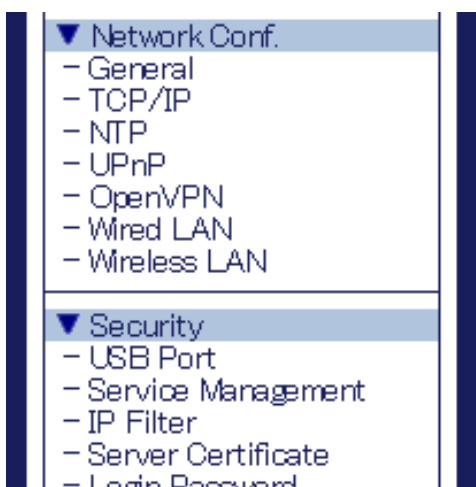

4. Click **Smart Wireless Setup** tab.

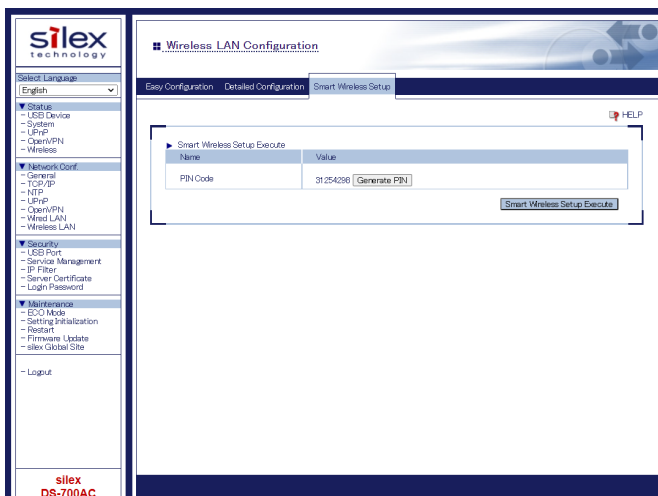

PIN Code Method

1. Check the PIN code on the Web page.
Keep displaying the Web page as it will be used again after you enter the PIN code on the Access Point side.

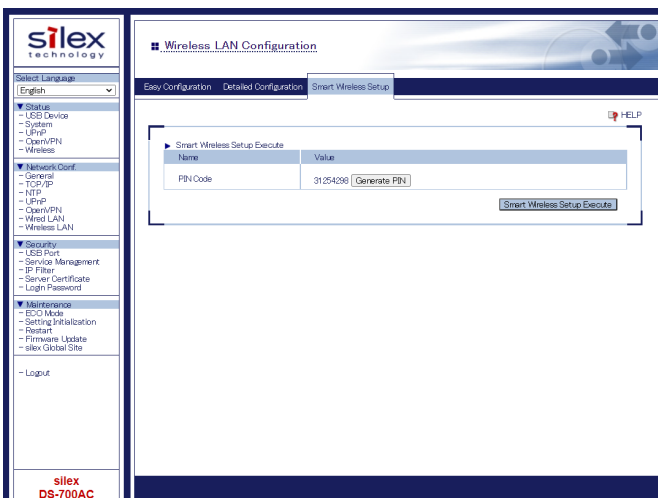

Note

- To change the PIN code, click **Generate PIN**. A new PIN code will be issued.

2. Open the Web page of Access Point using the Web browser (Internet Explorer, Microsoft Edge, etc).
Enter the PIN code and start the WPS on that page.

3. Go back to the Smart Wireless Setup page of DS-700AC after the WPS is started on the Access Point.
Click **Smart Wireless Setup Execute**.

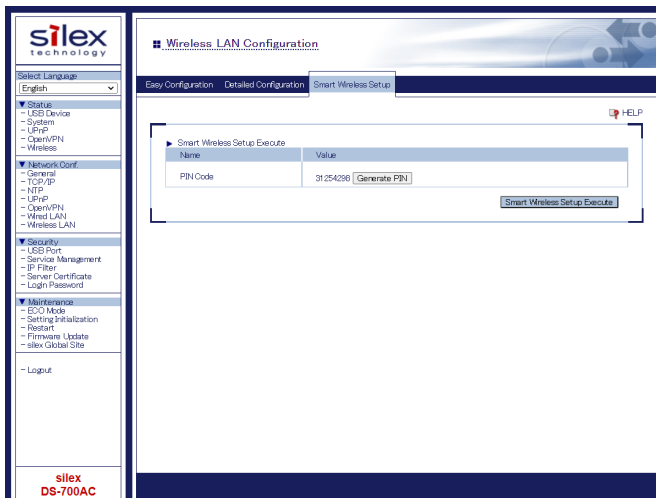

4. The Smart Wireless Setup will begin.

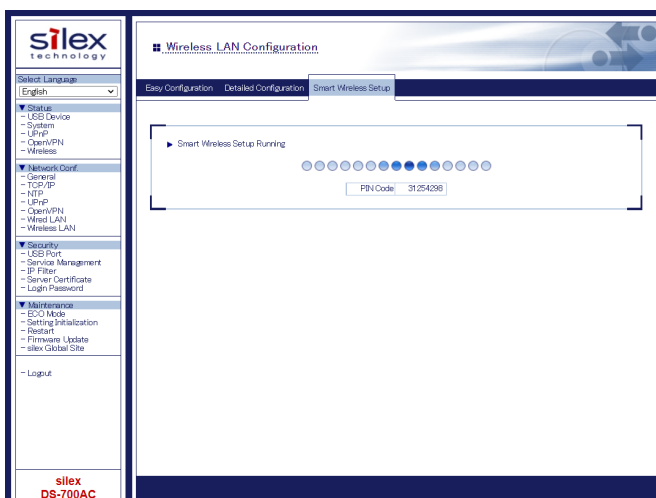

5. When the configuration is completed, DS-700AC will be configured with the same setting as the wireless router.

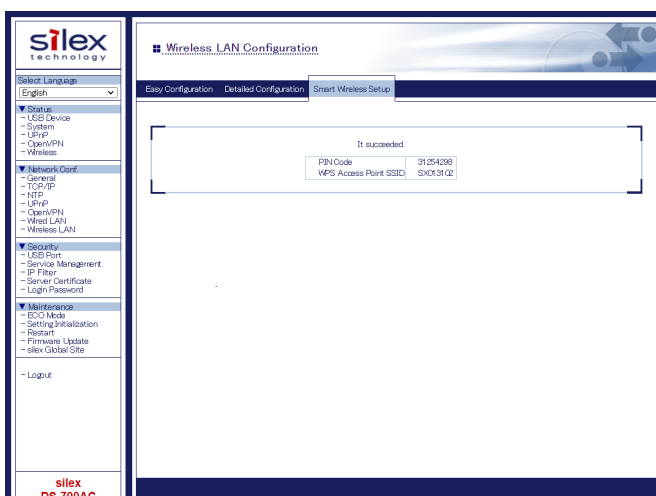

- 6.** Remove the power plug from the outlet and the network cable from DS-700AC.

- 7.** Connect the USB device that you wish to share over the network to DS-700AC using a USB cable and insert the power plug of DS-700AC into the outlet.

8-4. Security Feature

This page explains how to configure the access control setting. For each configuration page, the password entry will be required.

8-4-1. USB Port Setting

1. Access the Web page of DS-700AC.



- For how to display the Web page of DS-700AC, refer to **8-1-1. Displaying the Web page of DS-700AC.**

Note

2. The login page is displayed.
Enter the password for DS-700AC and click **Login**.

Welcome to DS-700AC

Enter the password, and click [Login]

Password

Login

Select Language
English

3. The Web page of DS-700AC is displayed.
From the left menu on the Web page, click **Security - USB Port**.

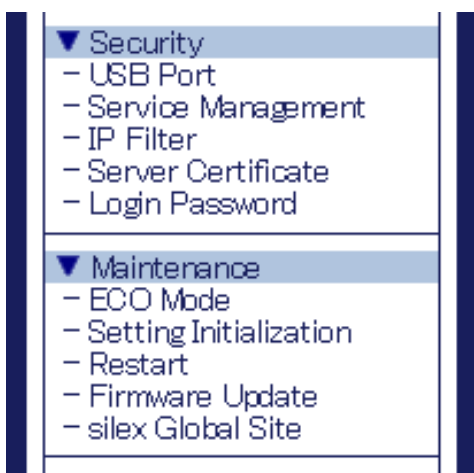

- The USB Port Configuration page is displayed. Configure each setting and click **Submit**.

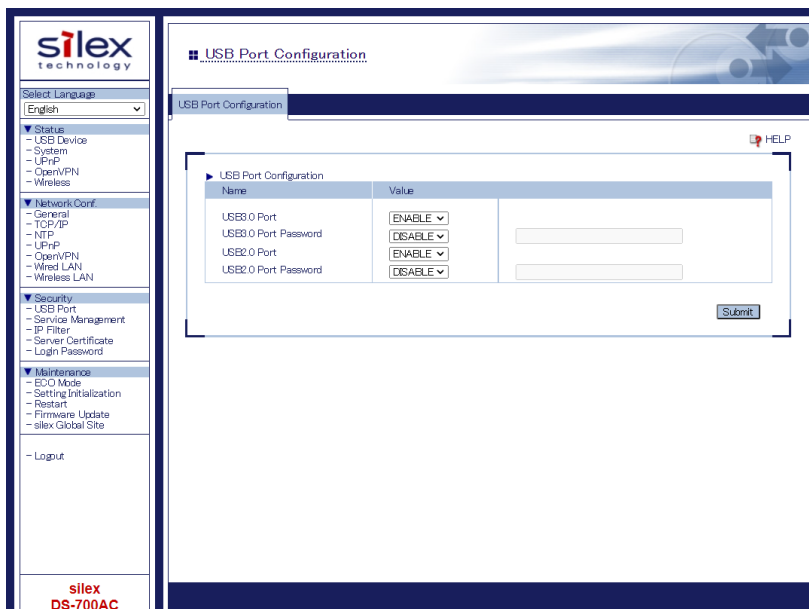

<USB Port Configuration>

Name	Details	Default
USB3.0 Port	Enable/Disable USB3.0 port	Enable
USB3.0 Port Password	Restrict the USB device access by configuring a password to USB3.0 port when the USB device server feature is used. When ENABLE is selected, the configured password is activated and the password authentication performs when a device connected to USB3.0 port is used over a network.	Disable
USB2.0 Port	Enable/Disable USB2.0 port	Enable
USB2.0 Port Password	Restrict the USB device access by configuring a password to USB2.0 port when the USB device server feature is used. When ENABLE is selected, the configured password is activated and the password authentication performs when a device connected to USB2.0 port is used over a network.	Disable



- The USB3.0 port of DS-700AC does not support connection with a USB HUB, USB HUB embedded device and USB video converter.
- The USB3.0 port of DS-700AC does not support the devices with more than 16 endpoints.

5. The Restart page is displayed. Click **Restart** to restart DS-700AC. The changes will take effect after restart.

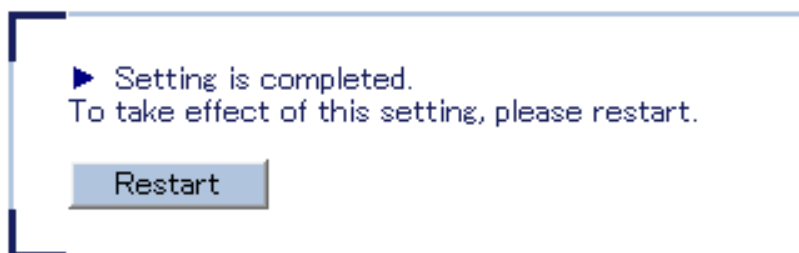

6. When the login page is displayed, the reboot is completed. Finish the Web browser.

8-4-2. Using Service Management Configuration

1. Access the Web page of DS-700AC.



- For how to display the Web page of DS-700AC, refer to **8-1-1. Displaying the Web page of DS-700AC.**

Note

2. The login page is displayed. Enter the password for DS-700AC and click **Login**.

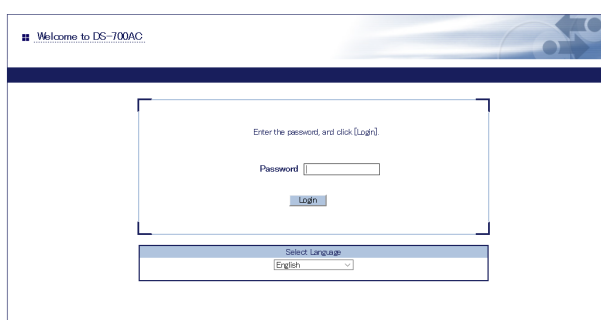

3. The Web page of DS-700AC is displayed.
From the left menu on the Web page, click **Service Management**.



4. The Service Management Configuration page is displayed.
Configure each setting and click **Submit**.

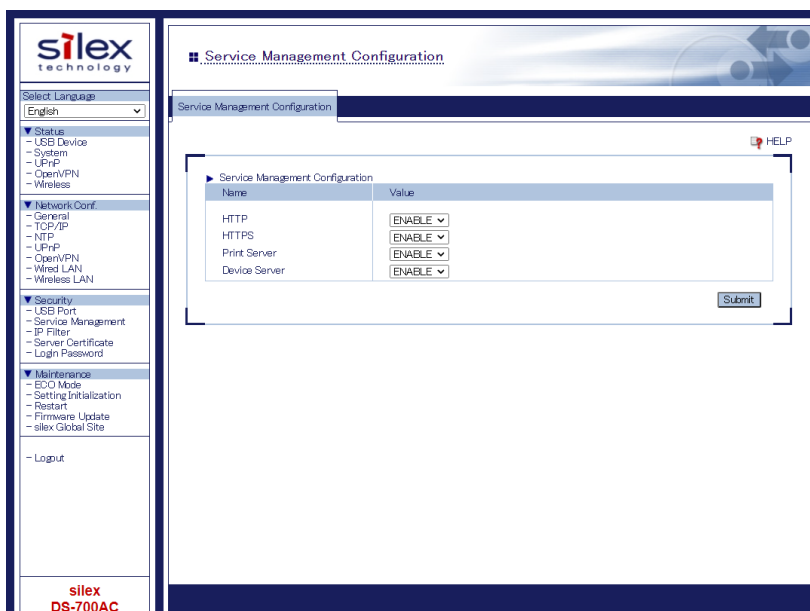

<Service Management Configuration>

Name	Details	Default
HTTP	Enable/Disable access to DS-700AC using HTTP. If ENABLE is selected, access to DS-700AC is allowed, and if DISABLE is selected, it is denied. * If this setting is disabled, you will not be able to access the Web page unless DS-700AC is reset to factory defaults.	Enable
HTTPS	Enable/Disable access to DS-700AC using HTTPS. If ENABLE is selected, access to DS-700AC is allowed, and if DISABLE is selected, it is denied. * If this setting is disabled, you will not be able to access the Web page unless DS-700AC is reset to factory defaults.	Enable
Print Server	Enable/Disable access to DS-700AC when the print server feature is used. If ENABLE is selected, access to DS-700AC is allowed, and if DISABLE is selected, it is denied.	Enable
Device Server	Enable/Disable access to DS-700AC when the device server feature is used. If ENABLE is selected, access to DS-700AC is allowed, and if DISABLE is selected, it is denied. ENABLE	Enable

- The Restart page is displayed. Click **Restart** to restart DS-700AC. The changes will take effect after restart.



- When the login page is displayed, the reboot is completed. Finish the Web browser.

8-4-3. Filtering Accesses from a Particular PC

This page explains how to restrict access from particular PCs using an IP filter function.



- If this function is used, the communication speed may decrease since network communication is monitored.

1. Access the Web page of DS-700AC.



Note

- For how to display the Web page of DS-700AC, refer to **8-1-1. Displaying the Web page of DS-700AC.**

2. The login page is displayed.
Enter the password for DS-700AC and click **Login**.

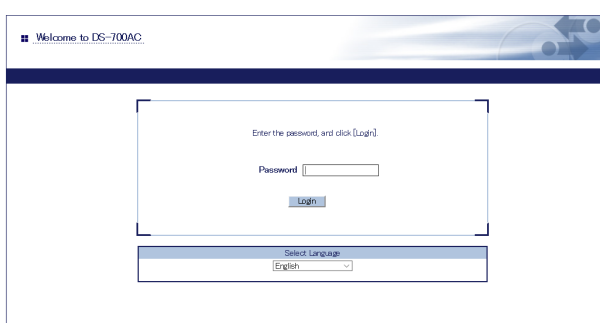

3. The Web page of DS-700AC is displayed.
From the left menu on the Web page, click **Security - IP Filter**.

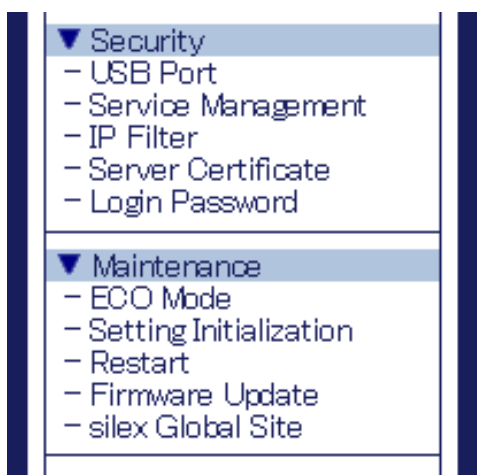

4. The IP Filter Configuration page is displayed. Configure each setting and click **Submit**. To configure the IPv6 filter, click the **IPv6 Filter Configuration** tab.



Name	Details	Default
Filter Mode	Set an IP address access filter (ALLOW/DENY). When ALLOW is set, only access from the registered IP address range is allowed, and when DENY is set, access from the registered IP address range is denied.	DENY
Starting Address/ Ending Address	Set start/end addresses to specify the range of access filter. Example: Not configured: 0.0.0.0/0.0.0.0 Access from 192.168.0.0-192.168.0.255 is allowed/denied. 192.168.0.0/192.168.0.255 Access only from the specified host is allowed/denied. 192.168.0.1/192.168.0.1 Any access is allowed/denied. 0.0.0.0/255.255.255.255	0.0.0.0 / 0.0.0.0
Starting Address/ Ending Address(IPv6 Filter Configuration)	Set start/end addresses to specify the range of access filter. Example: Not configured: ::: 2001::/2001::ffff is allowed/denied. 2001::/2001::ffff Access only from the specified host is allowed/denied. 2001::1/2001::1 Any access is allowed/denied. ::/ffff:ffff:ffff:ffff:ffff:ffff:ffff:ffff	::/::

5. The Restart page is displayed. Click **Restart** to restart DS-700AC. The changes will take effect after restart.

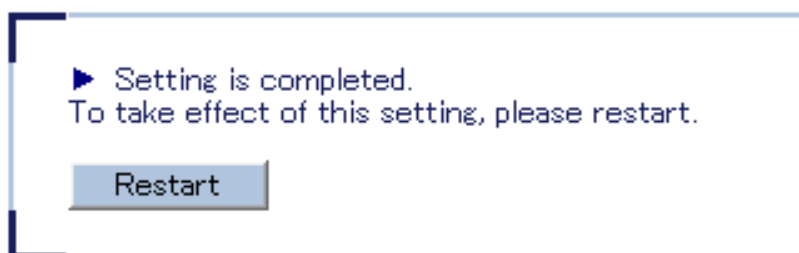

6. When the login page is displayed, the reboot is completed. Finish the Web browser.

8-4-4. Server Certificate

This page explains how to set a self-signed certificate on Web page in order to enable configuration via HTTPS.

1. Access the Web page of DS-700AC.



Note

- For how to display the Web page of DS-700AC, refer to **8-1-1. Displaying the Web page of DS-700AC.**

2. The login page is displayed.
Enter the password for DS-700AC and click **Login**.

Welcome to DS-700AC

Enter the password, and click [Login]

Password

[Login]

Select Language
English

3. The Web page of DS-700AC is displayed.
From the left menu on the Web page, click **Security - Server Certificate**.

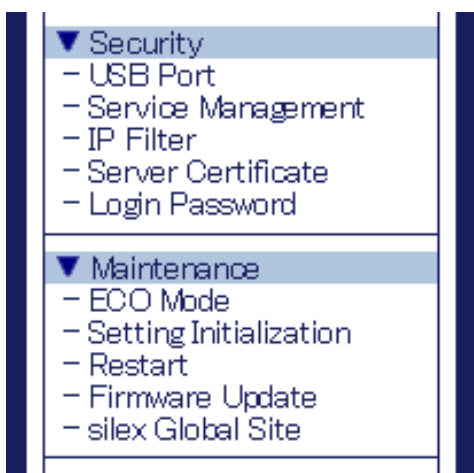

- The Server Certificate Create page is displayed. Configure each setting and click **Submit**.

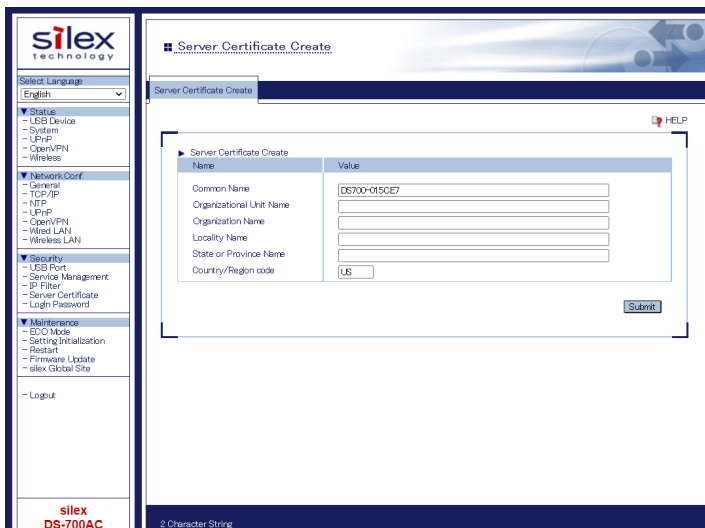

<Server Certificate Create>

Name	Details	Default
Common Name	Set a server name for the server certificate (1 to 64 alphanumeric characters). * The following symbols and spaces can be used. .,- &	DS700-XXXXXX (XXXXXX is the last 6 digits of the MAC Address)
Organizational Unit Name	Set an organization unit name for the server certificate (0 to 64 alphanumeric characters). * The following symbols and spaces can be used. .,- &	--
Organization Name	Set an organization name for the server certificate (0 to 64 alphanumeric characters). * The following symbols and spaces can be used. .,- &	--
Locality Name	Set a city/locality for the server certificate (0 to 128 alphanumeric characters). * The following symbols and spaces can be used. .,- &	--
State or Province Name	Set a state/province for the server certificate (0 to 128 alphanumeric characters). * The following symbols and spaces can be used. .,- &	--
Country/Region code	Set a country/region for the server certificate (2 alphanumeric characters).	JP



Note

- Validity period of certificate is set to 2037/12/31.

5. The Restart page is displayed. Click **Restart** to restart DS-700AC. The changes will take effect after restart.

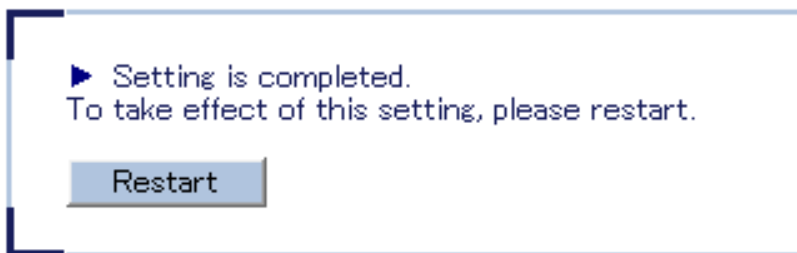

6. When the login page is displayed, the reboot is completed. Finish the Web browser.

8-4-5. Changing Root Password

This page explains how to change the password for DS-700AC.

1. Access the Web page of DS-700AC.



Note

- For how to display the Web page of DS-700AC, refer to **8-1-1. Displaying the Web page of DS-700AC.**

2. The login page is displayed.
Enter the password for DS-700AC and click **Login**.

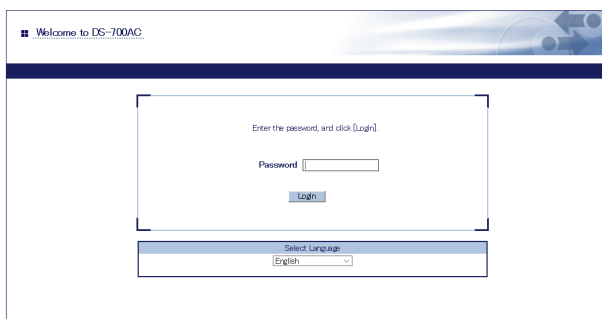

Note

- By default, no password is configured to DS-700AC.

3. The Web page of DS-700AC is displayed.
From the left menu on the Web page, click **Security - Login Password**.



4. The Password Configuration page is displayed.
Enter the password to both **New Password** and **Confirm New Password** and click **Submit**.

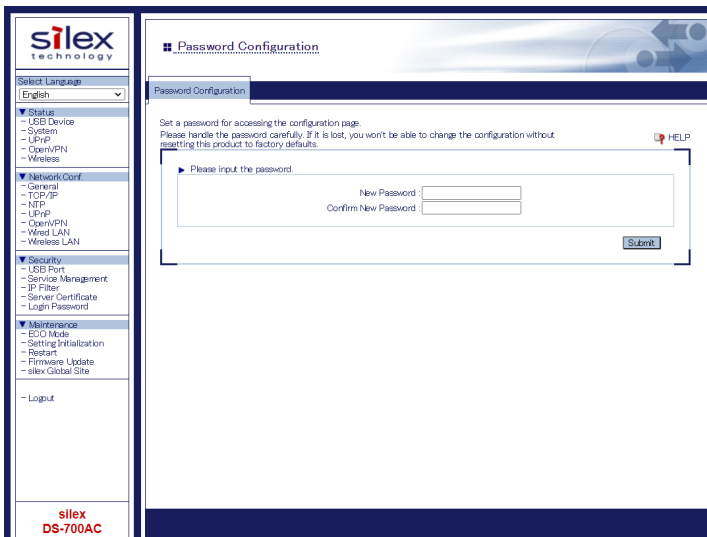

<Please input the password.>

Name	Details	Default
New Password	Set the administrative password in ASCII string (up to 8 characters). This password is used as authentication password for changing the settings from the Web page.	--
Confirm New Password	Enter the same password for confirmation.	--



TIP

- Please handle the password carefully. If the password is lost, you will not be able to change the settings unless DS-700AC is reset to the factory default setting.

5. The Restart page is displayed. Click **Restart** to restart DS-700AC.
The changes will take effect after restart.

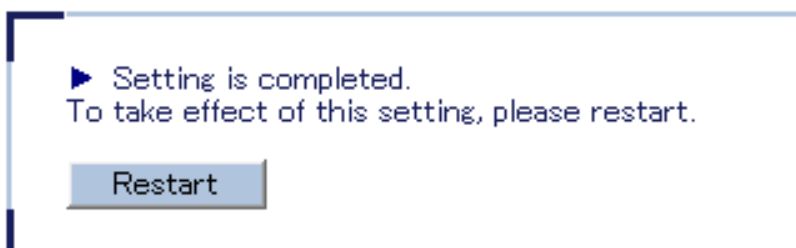

6. When the login page is displayed, the reboot is completed.
Finish the Web browser.

8-5. Maintenance Feature

8-5-1. About ECO Mode

This page explains ECO Mode, a power-saving mode for DS-700AC.

About ECO Mode

ECO Mode is a power-saving mode that DS-700AC switches to when it has been idle for a specified period of time. When in ECO Mode, USB Bus power is switched off to save power. With ECO Mode enabled, you can save power for DS-700AC and the connected USB devices.

Turning on ECO Mode setting

ECO Mode can be enabled or disabled. Also, the amount of time before switching to ECO Mode can be specified

1. Access the Web page of DS-700AC.



Note

- For how to display the Web page of DS-700AC, refer to **8-1-1. Displaying the Web page of DS-700AC.**

2. The login page is displayed.
Enter the password for DS-700AC and click **Login**.

Welcome to DS-700AC

Enter the password, and click [Login]

Password

Login

Select Language
English

3. The Web page of DS-700AC is displayed.
From the left menu on the Web page, click **Maintenance - ECO Mode**.

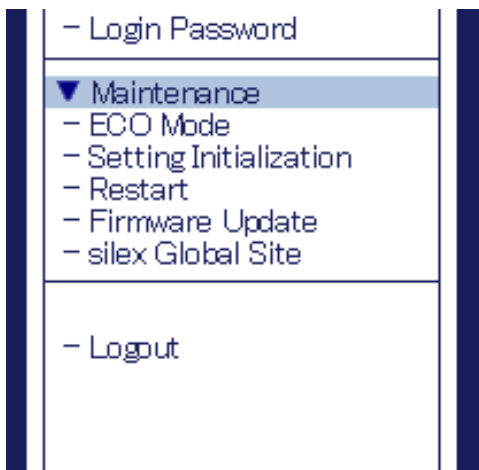

4. The ECO Mode Configuration page is displayed.
Configure each setting and click **Submit**.

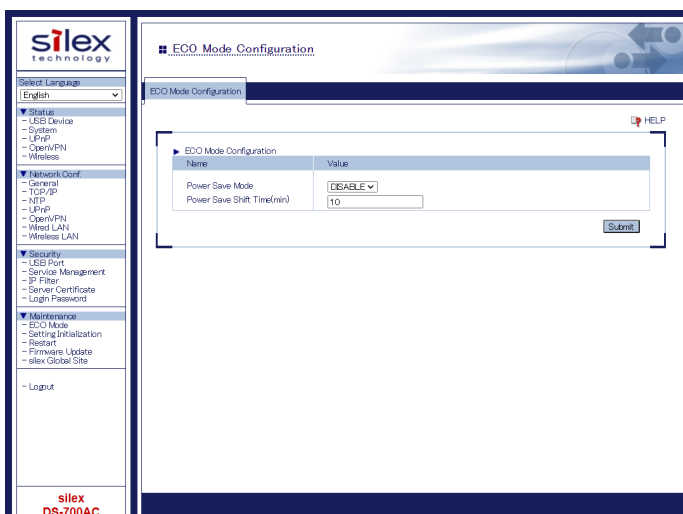

<ECO Mode Configuration>

Name	Details	Default
Power Save Mode	If DS-700AC is idle for the specified amount of time, it will automatically switch into ECO mode. When the USB device connection utility is started or DS-700AC is accessed for a particular purpose, DS-700AC will automatically wake up from ECO mode.	DISABLE
Power Save Shift Time(min)	Specify the amount of time until DS-700AC switches into ECO mode, when the ECO mode setting is enabled (min). (3-60 integer value)	10

5. The Restart page is displayed. Click **Restart** to restart DS-700AC. The changes will take effect after restart.



6. When the login page is displayed, the reboot is completed. Finish the Web browser.

Conditions to start ECO Mode

DS-700AC will switch to ECO Mode when it is idle for a certain period of time specified by Power Save Shift Time (minutes) and the following conditions are met:

- **Power Save Mode** is set to **ENABLE**.
- SX Virtual Link is not running on the network DS-700AC is connected to.
- Printing using the print server feature is not performed.



Note

- Because SX Virtual Link regularly communicates with DS-700AC, DS-700AC will not switch to ECO Mode if SX Virtual Link is running. To start ECO Mode, shut down all PCs with SX Virtual Link installed or close SX Virtual Link on each PC.
- If printing using the print server feature is performed, DS-700AC will wake up from ECO Mode.

Conditions to finish ECO Mode

ECO Mode will finish in the following conditions.

Once ECO Mode is finished, the USB Bus power will automatically be enabled on DS-700AC.

- SX Virtual Link is running on the network DS-700AC is connected to.
- Printing using the print server feature is performed.

8-5-2. Resetting to Factory Defaults

This page explains how to reset DS-700AC to the factory default settings.

If DS-700AC has been used in a particular network and you wish to change the settings to use it for another network, please initialize DS-700AC first according to the instructions below:



TIP

- It is recommended to take notes of the current settings. You cannot restore it once the factory default configuration is complete.
- Before you start, please make sure that no PCs are currently linked.
- Do not turn off DS-700AC while resetting to factory default.
- Do not press the push switch when DS-700AC is turned on again after it was reset to the factory default settings.

Resetting using the push switch on DS-700AC

1. Remove the AC plug from the electric outlet.

2. Push and hold the push switch(1) while inserting the AC plug back into the power outlet (2). Continue holding.
When the LINK LED(orange) turns on, the factory default configuration begins.

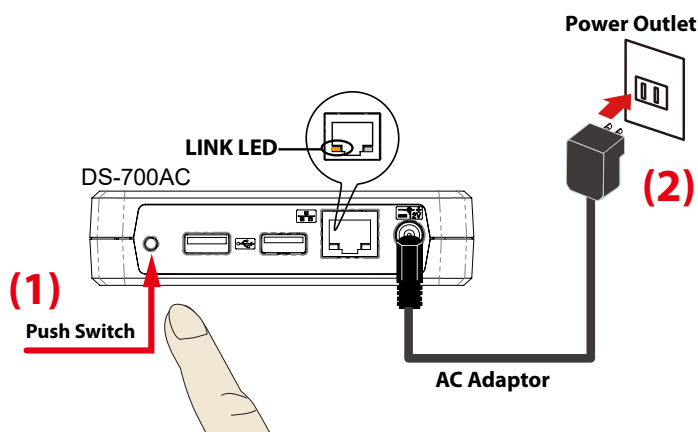

3. Release the push switch when the LINK LED(orange) turns off. The factory default configuration is completed.



TIP

- Do not release the push switch until the LINK LED(orange) turns off.

Resetting from the Web page

1. Access the Web page of DS-700AC.



Note

- For how to display the Web page of DS-700AC, refer to **8-1-1. Displaying the Web page of DS-700AC.**

2. The login page is displayed.
Enter the password for DS-700AC and click **Login**.

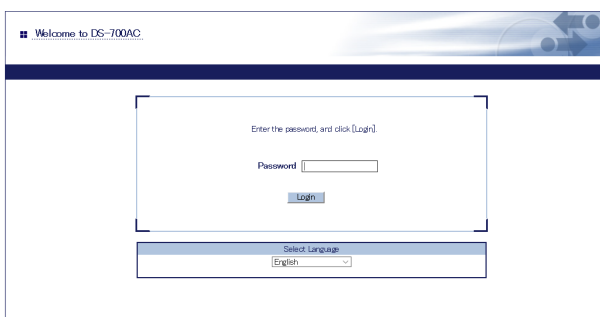

3. The Web page of DS-700AC is displayed.
From the left menu on the Web page, click **Maintenance - Setting Initialization**.



- The factory default configuration page is displayed. Click **Yes**.

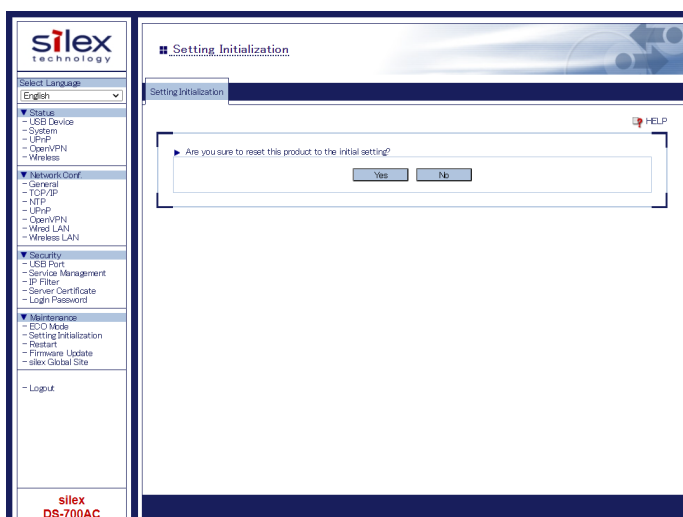

- A confirmation message is displayed. Click **OK**.

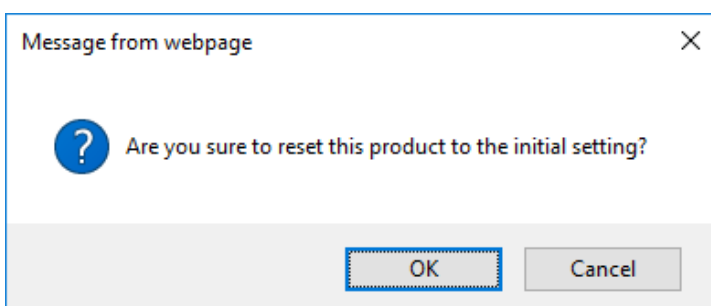

- The factory default configuration will begin.

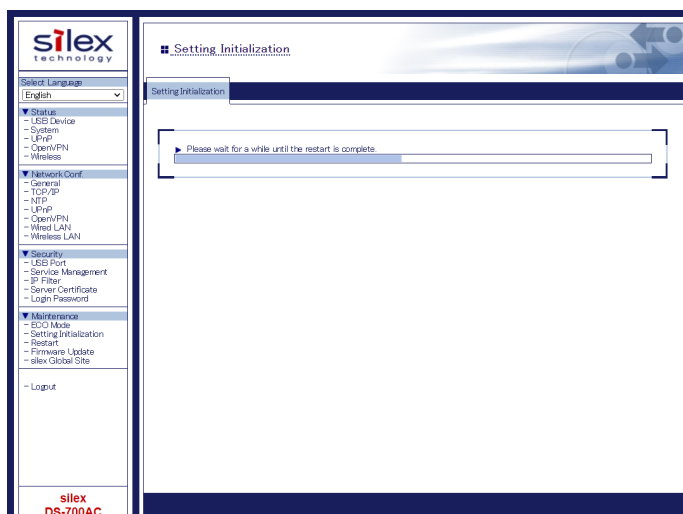

- When the login page is displayed, the factory default configuration is completed. Finish the Web browser.

8-5-3. Rebooting DS-700AC

This page explains how to reboot DS-700AC.



- Before you start, please make sure that no PCs are currently linked.

Manual reboot at the unit side

1. Unplug the AC plug of DS-700AC from the power outlet.
2. Insert the AC plug back into the power outlet again.
3. The reboot will be complete in 30 seconds.

Remote reboot from the Web page

1. Access the Web page of DS-700AC.



Note

- For how to display the Web page of DS-700AC, refer to **8-1-1. Displaying the Web page of DS-700AC.**

2. The login page is displayed.
Enter the password for DS-700AC and click **Login**.

Welcome to DS-700AC

Enter the password, and click [Login]

Password

Login

Select Language
English

3. The Web page of DS-700AC is displayed.
From the left menu on the Web page, click **Maintenance - Restart**.

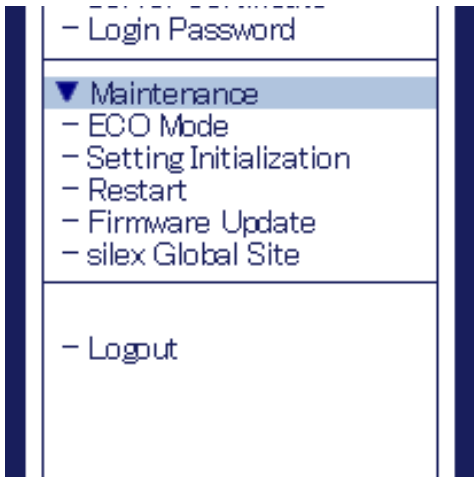

4. The Restart page is displayed.
Click **Yes**.

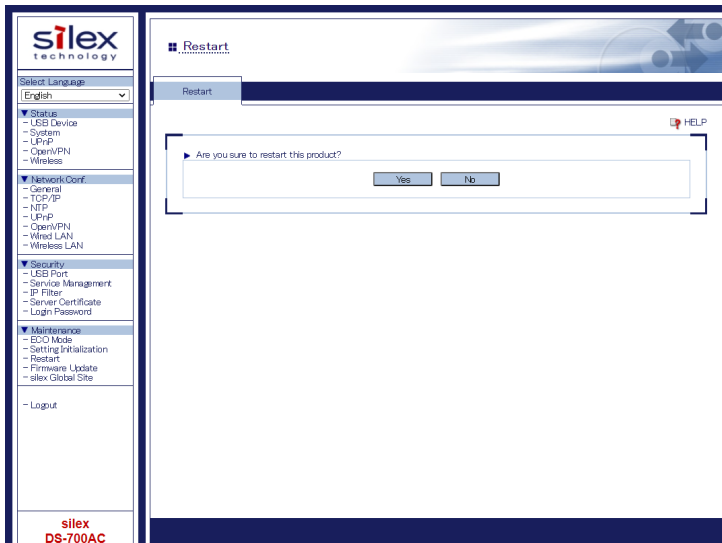

5. The reboot will be complete in 30 seconds.

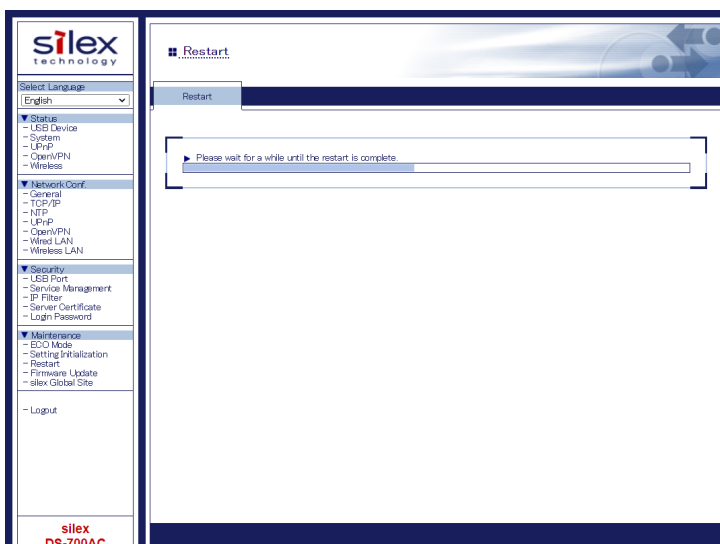

6. When the login page is displayed, the reboot is completed.
Finish the Web browser.

8-5-4. Updating Firmware

This page explains how to update the DS-700AC firmware.

Downloading the latest firmware file

Please download the latest firmware file from our website.

For how to download the firmware file, refer to **4-2. Downloading the Utilities**.

Updating the firmware



TIP

- Before you start, please make sure that no PCs are currently linked.
- Do not turn off DS-700AC while the firmware update is in process.

1. Access the Web page of DS-700AC.



Note

- For how to display the Web page of DS-700AC, refer to **8-1-1. Displaying the Web page of DS-700AC**.

2. The login page is displayed.
Enter the password for DS-700AC and click **Login**.

Welcome to DS-700AC

Enter the password, and click [Login].

Password

Login

Select Language
English

- The Web page of DS-700AC is displayed.
From the left menu on the Web page, click **Maintenance - Firmware Update**.

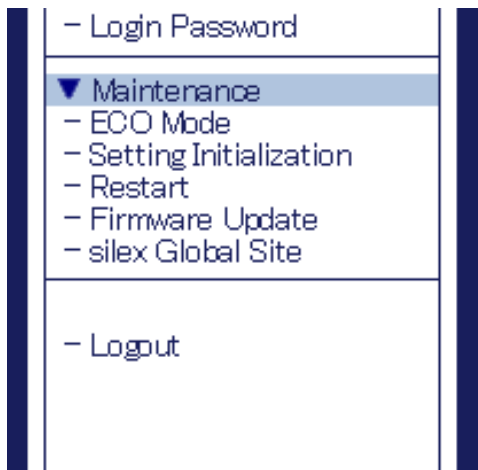

- The Firmware Update page is displayed.
Click Browse to select the firmware file to be loaded to DS-700AC.
Check that the file name is displayed in **New firmware** field and click **Update**.

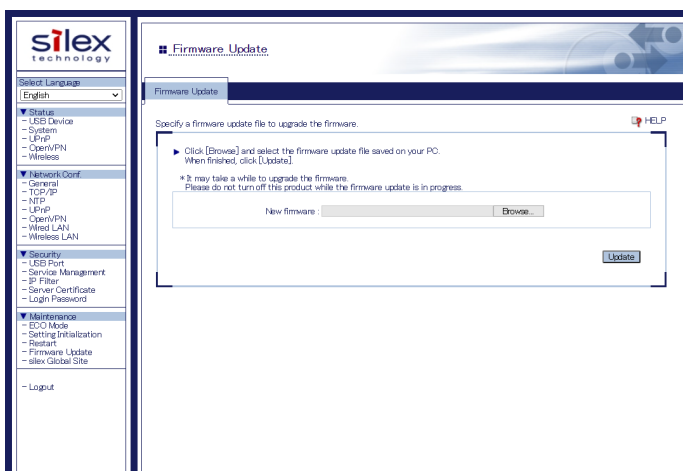

- A confirmation message is displayed. Click **OK**.

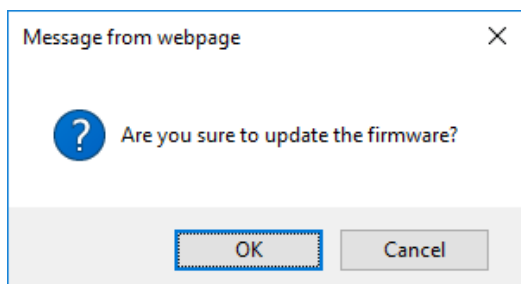

6. The firmware update will begin.

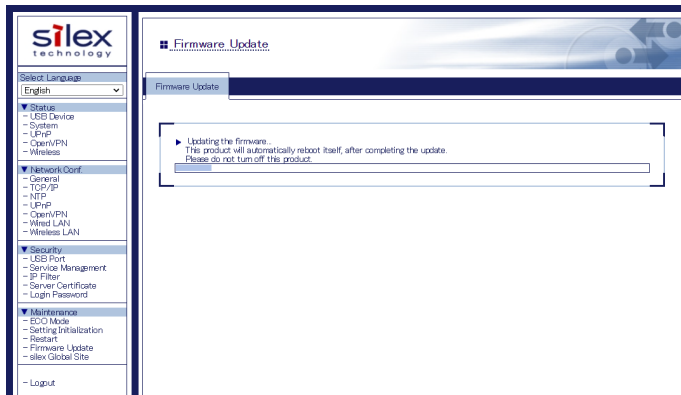

7. When the login page is displayed, the firmware update is completed.
See the bottom left of the login page and check the version information is changed.

8. Finish the Web browser.

8-6. Using USB Devices over the Internet

By using a router that has NAT function, the USB devices can be used via the Internet.

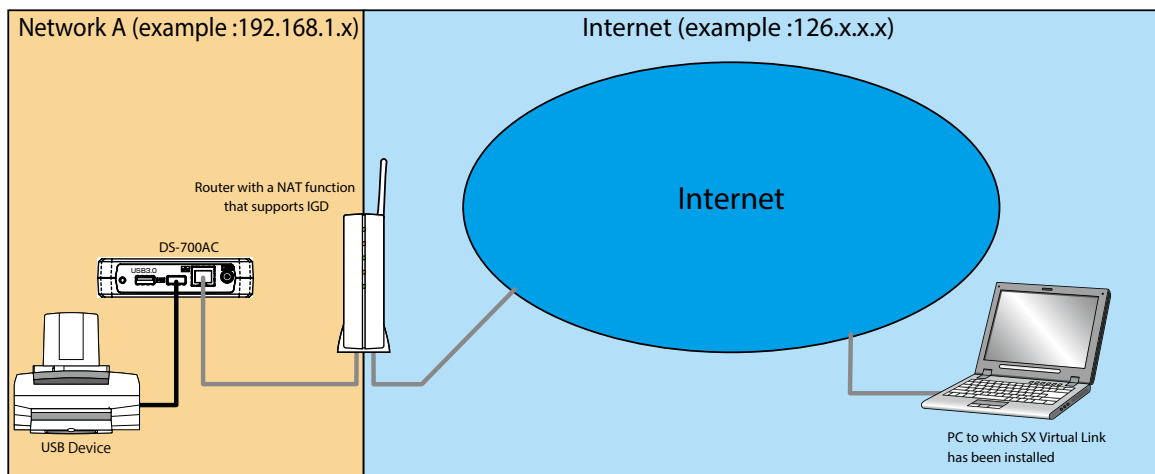

The following devices and information are required to use the USB devices via the Internet.

- A router with a NAT function that supports UPnP Internet Gateway Device
- A host name that has been set for Dynamic DNS
- Router port forwarding setting



- To use USB devices via the Internet, the DS-700AC firmware version must be 1.1.0 or higher, and the SX Virtual Link version must be 5.1.0 or higher.



- If your router does not support UPnP, a rule of port forwarding to DS-700AC needs to be manually set.
- For the Dynamic DNS settings, refer to the operating manual that comes with your router.

8-6-1. Using USB Devices over the Internet

To use USB devices via the Internet, the DS-700AC and SX Virtual Link settings need to be configured. The following describes how to use the UPnP client function.



TIP

- It is impossible to access the Web page of DS-700AC via the Internet.
- **UPnP Control** is set to **ENABLE** by default.

UPnP function setting

1. Access the Web page of DS-700AC.



Note

- For how to display the Web page of DS-700AC, refer to **8-1-1. Displaying the Web page of DS-700AC.**

2. The login page is displayed.
Enter the password for DS-700AC and click **Login**.

3. The Web page of DS-700AC is displayed.
From the left menu on the Web page, click **Network Conf. - UPnP**.

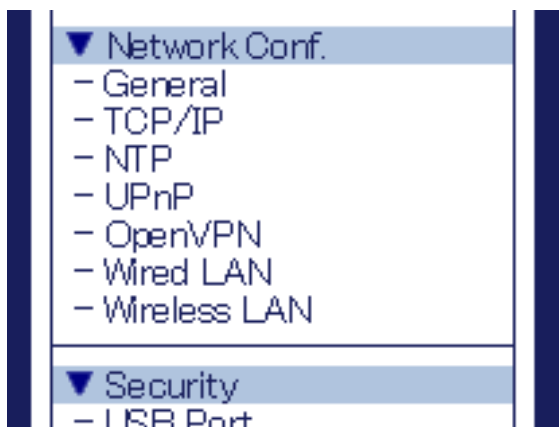

- UPnP Configuration page is displayed.
Select **ENABLE** for **UPnP Control** and click **Submit**.

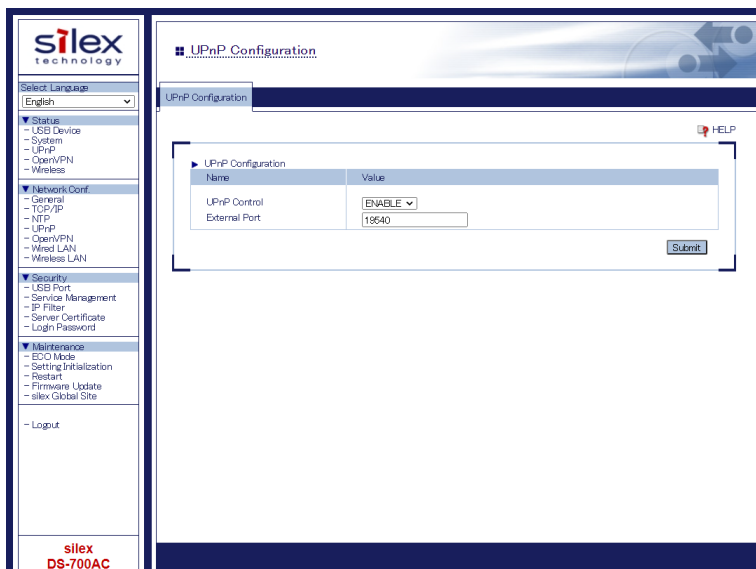

Note

- DS-700AC uses the **External Port** number to set the external port for a port forwarding function. If this port number has already been used for another device, or when there are multiple DS-700AC units, it needs to be changed.

- The Restart page is displayed. Click **Restart** to restart DS-700AC.
The changes will take effect after restart.

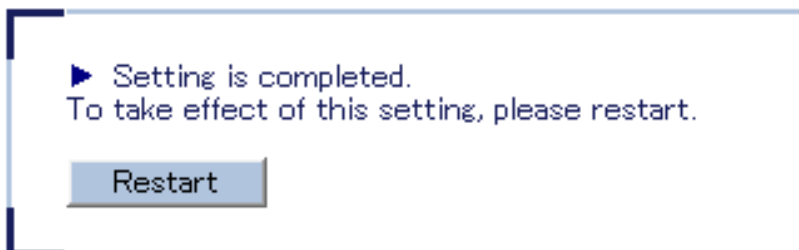

- When the login page is displayed, the reboot is completed.

7. Enter the password for DS-700AC and click **Login**.

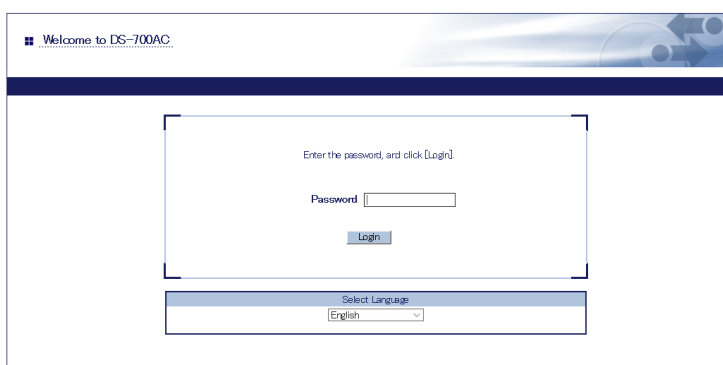

Welcome to DS-700AC.

Enter the password, and click [Login]

Password

Login

Select Language
English

8. The Web page of DS-700AC is displayed.
From the left menu on the Web page, click **Status - UPnP**.

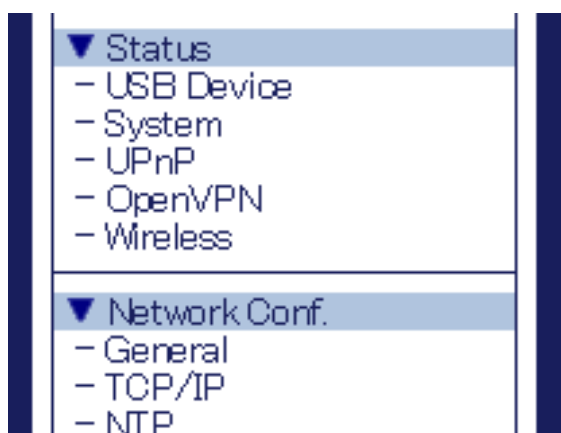

9. UPnP Status page is displayed.
Check the value at **External Port** under **IGD Register Information**.

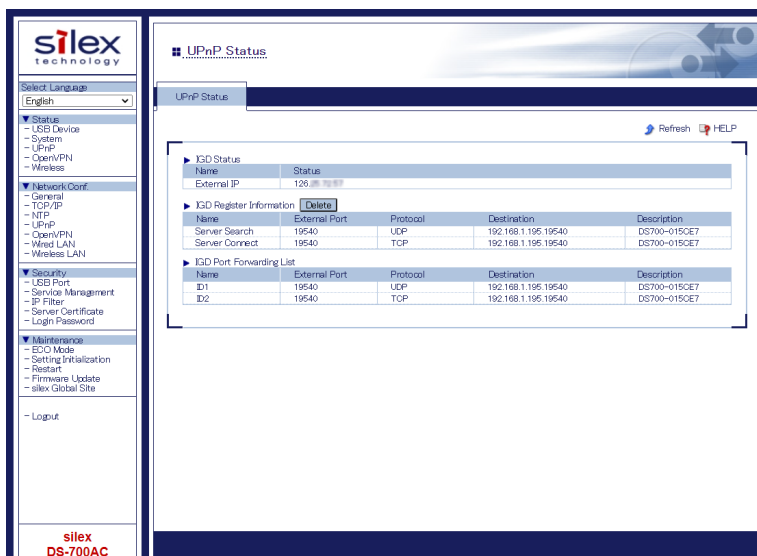

Note

- If the status of **IGD Register Information** is "**Registration Failure**", it is impossible to connect to DS-700AC via NAT.
- The reason of "**Registration Failure**" might be the followings.
 - The external port is already in use.
 - The destination IP address is already in use.

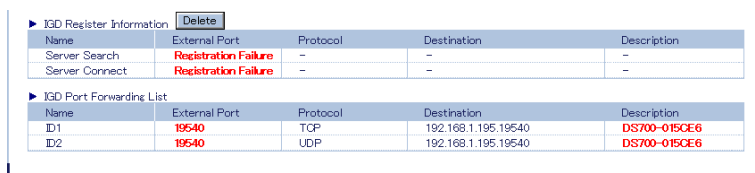

SX Virtual Link Setting

1. Start SX Virtual Link.



- For how to start SX Virtual Link, refer to **7. Using USB Devices Connected to DS-700AC**.

Note

2. In SX Virtual Link's main window, click the **Options** button ().

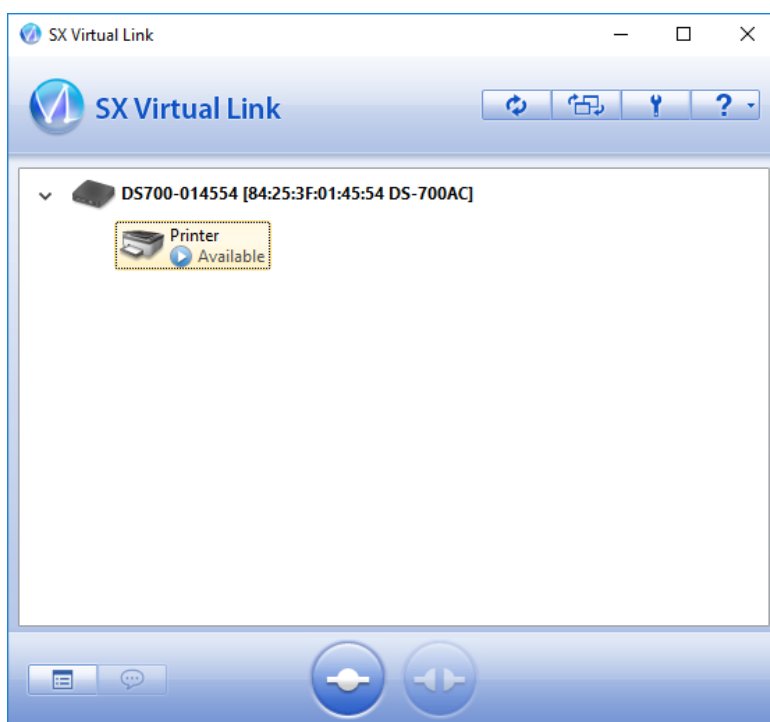

3. The **Options** window is displayed.
Click the **Search for device servers** tab.

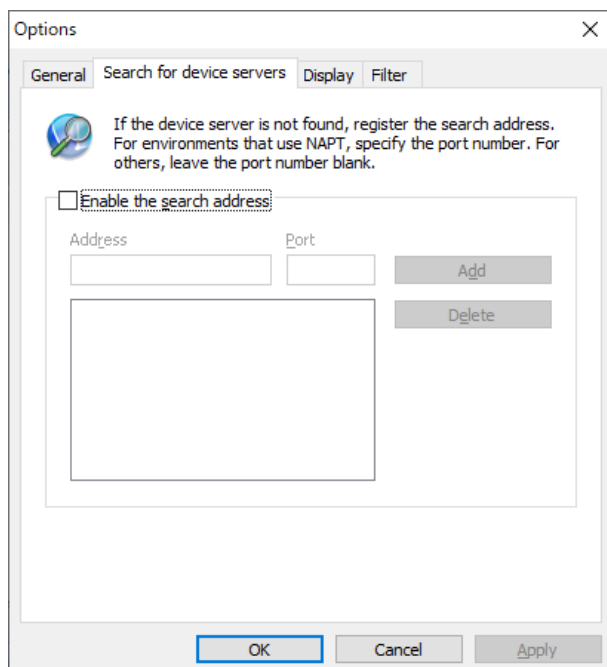

4. Check the check box of the **Enable the search address**.
Enter the host name (the one registered to Dynamic DNS) for **Address**, and the port number you have checked at step 9 of **UPnP function setting** for **Port**, and click **OK**.

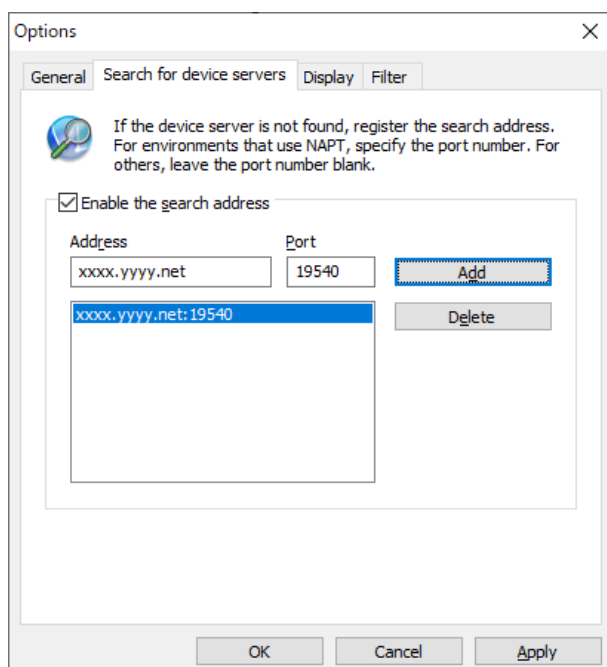

Note

- For **Address**, the external IP address of DS-700AC can be set. However, please note that the IP address changes automatically when DS-700AC is in use.
- When the **External Port** of DS-700AC is "19540", the **Port** setting can be skipped. However, if "19540" is already in use, the **Port** setting needs to be entered.
- For details on Dynamic DNS, refer to the operating manual that comes with your router.

8-6-2. Deleting Port Forwarding Setting

Before removing DS-700AC from network after using the USB device via the Internet, it is recommended to delete the port forwarding setting on DS-700AC. The following explains how to delete the port forwarding setting.



TIP

- The Web page of DS-700AC cannot be accessed via the Internet.
- If the deletion fails, the registered IGD information will not be deleted.

1. Access the Web page of DS-700AC.



Note

- For how to display the Web page of DS-700AC, refer to **8-1-1. Displaying the Web page of DS-700AC.**

2. The login page is displayed. Enter the password for DS-700AC and click **Login**.

3. The Web page of DS-700AC is displayed. From the left menu on the Web page, click **Status - UPnP**.

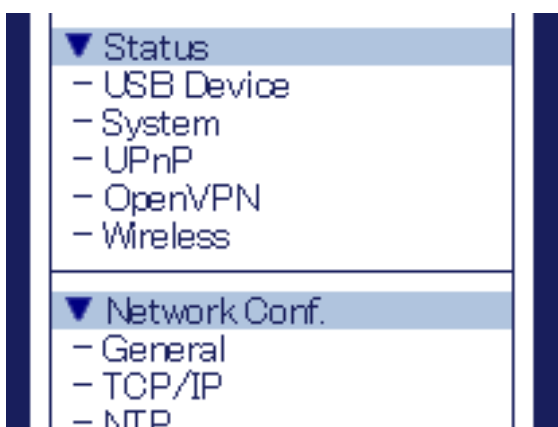

- 4. UPnP Status page is displayed.
Click **Delete**.

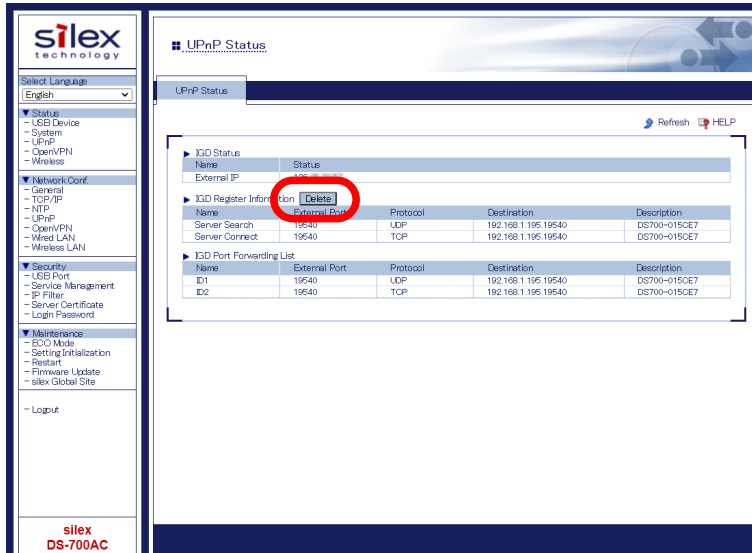

8-6-3. Using OpenVPN Client Function

DS-700AC supports the OpenVPN Client function. If this function is enabled, it is possible to connect to the VPN server configured for OpenVPN Client to establish VPN communication.

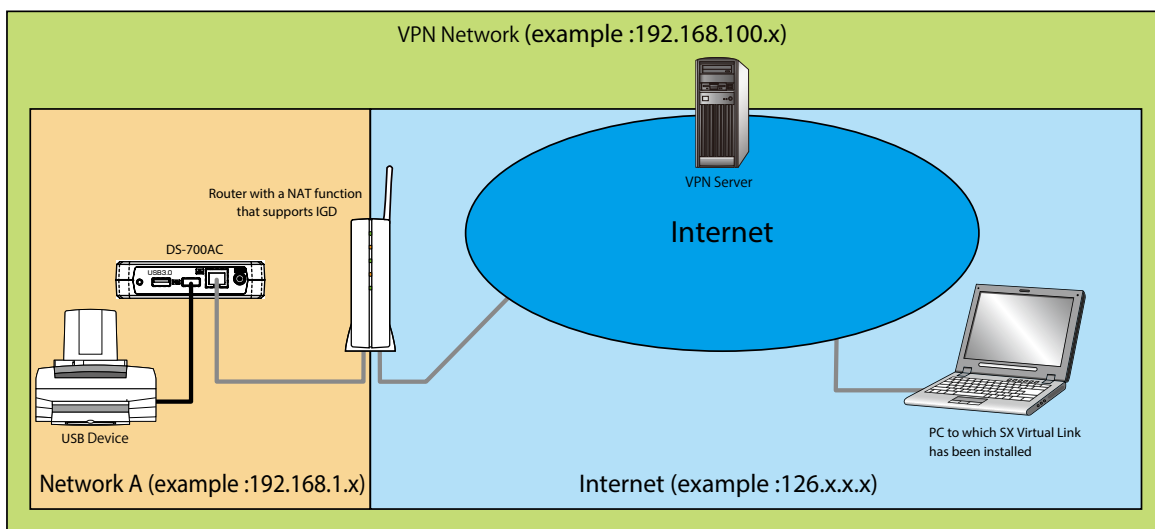

TIP

- VPN server is updated by vendors for purposes of functional expansion and security enhancement. When the update runs, it may not be possible to communicate with the VPN server since the client function of DS-700AC cannot meet the updated requirements on communication/encryption.
- VPN network environment needs to be established.
- You may need to pay for a VPN environment that includes Azure VPN Gateway. Please confirm the details of each service.



Note

- The functional operation has been confirmed with the following VPN server(s).
Azure VPN Gateway configured for OpenVPN Client
- The configuration file of OpenVPN can be downloaded from the Azure's portal. Create a CA certificate to register for VPN Gateway and a certificate to describe in the configuration file of OpenVPN. It needs to be reflected in the configuration file of OpenVPN in advance.
- Multicast and broadcast are not allowed for Azure VNET. To search for DS-700AC via Azure VPN Gateway, it is necessary to set the DS-700AC's IP address of VPN to the device server search address of SX Virtual Link.

OpenVPN Client function setting

1. Access the Web page of DS-700AC.



Note

- For how to display the Web page of DS-700AC, refer to **8-1-1. Displaying the Web page of DS-700AC.**

2. The login page is displayed.
Enter the password for DS-700AC and click **Login**.

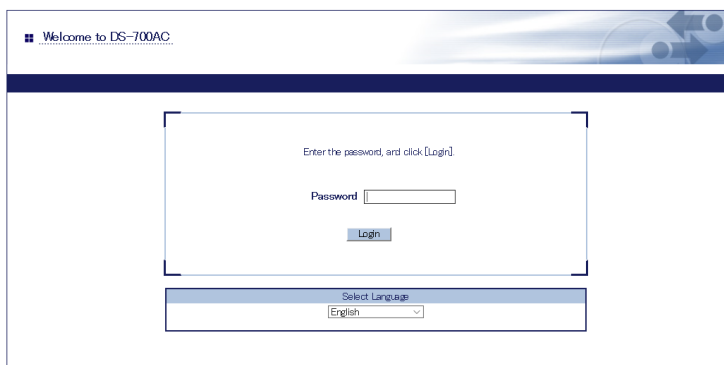

3. The Web page of DS-700AC is displayed.
From the left menu on the Web page, click **Network Conf. - OpenVPN**.

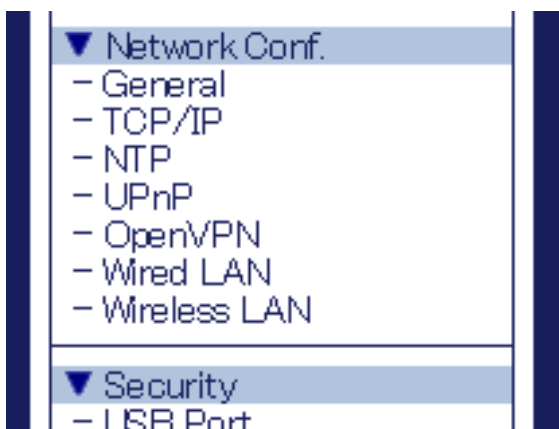

4. OpenVPN Configuration page is displayed.
Select **ENABLE** for **OpenVPN Client**.
Click **Browse**, select the OpenVPN configuration file and click **Submit**.

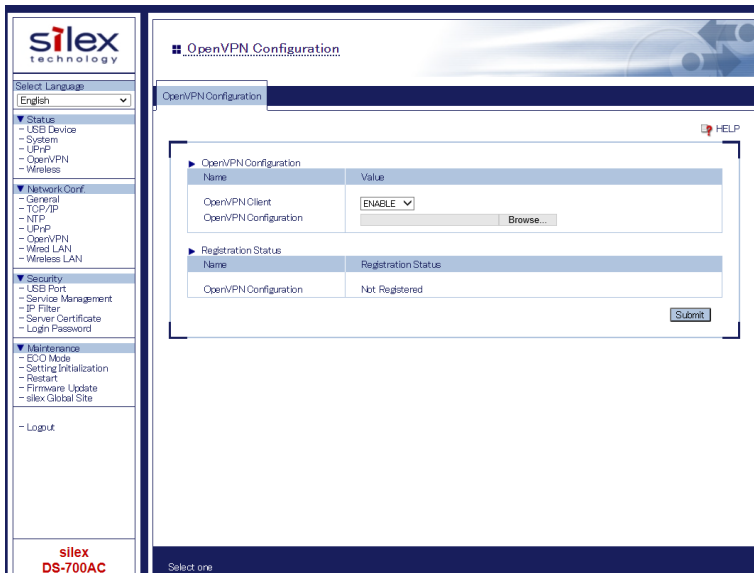

5. The Restart page is displayed. Click **Restart** to restart DS-700AC.
The changes will take effect after restart.

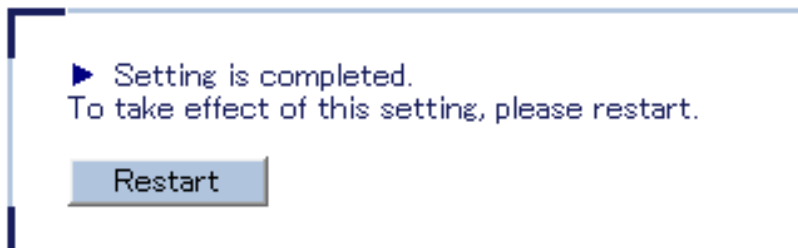

6. When the login page is displayed, the reboot is completed.
Finish the Web browser.

SX Virtual Link Setting

1. Start SX Virtual Link.



- For how to start SX Virtual Link, refer to **7. Using USB Devices Connected to DS-700AC**.

Note

2. In SX Virtual Link's main window, click the **Options** button ().

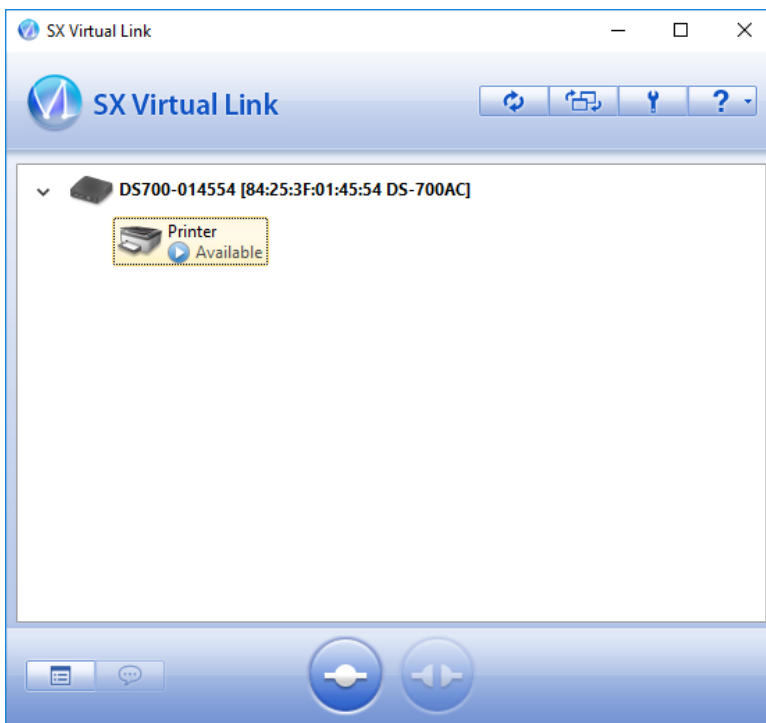

- The **Options** window is displayed.
Click the **Search for device servers** tab.

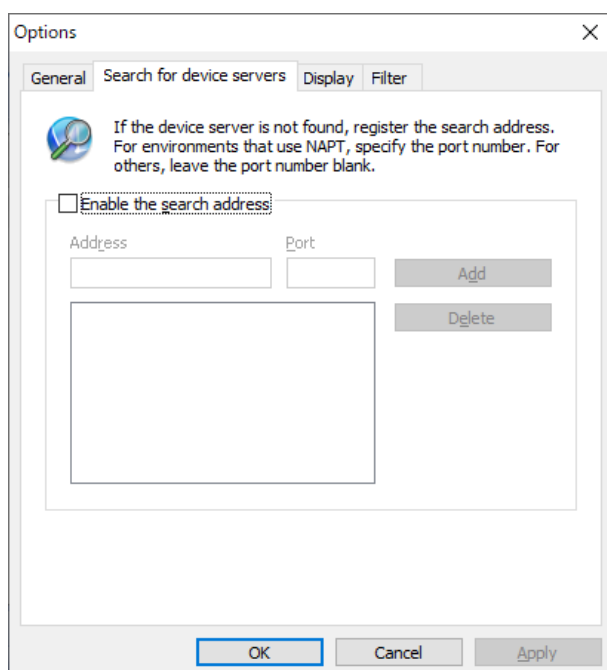

- Check the check box of **Enable the search address**, enter the DS-700AC's IP address of VPN for **Address** and click **OK**.

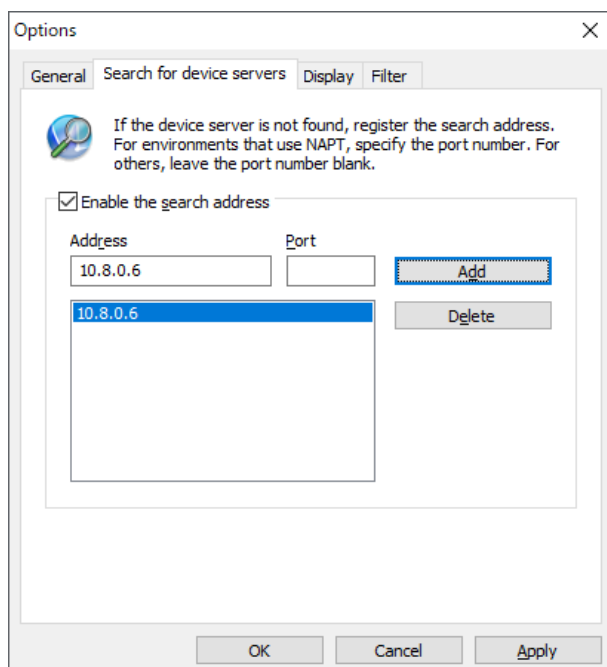

8-7. Using SX Virtual Link Lite

8-7-1. What is SX Virtual Link Lite?

This page explains the USB device connection service "SX Virtual Link Lite" to use DS-700AC.

SX Virtual Link Lite is a utility that runs as Windows service.

Difference from SX Virtual Link

- **USB device is automatically connected when PC is turned on**

By registering USB device at SX Virtual Link Lite Setting, it can automatically be connected when the PC is powered on.

You will not have to start SX Virtual Link to connect the USB device.

- **PC logon is not necessary**

USB device can be connected just by turning on PC. Logon is not necessary then.

- **Auto connection recovery**

When the USB device connection is lost as the device server is turned off, etc., it will be reconnected automatically when the device server is turned on again.



- When SX Virtual Link Lite fails to connect the USB device, reconnection does not perform. Also, error message is not displayed then.

- As long as the USB device is connected by SX Virtual Link Lite, it is impossible to connect such device by other utility such as SX Virtual Link.

8-7-2. Installing SX Virtual Link Lite

This page explains how to install the USB device connection utility "SX Virtual Link Lite" on your PC.

1. Extract the downloaded "Device Server Setup" file on your desktop.
Double-click "**Dssetup.exe**" contained in the "Device Server Setup" folder to start the "Device Server Setup" installer.
2. Click **Extra** in the menu window below.

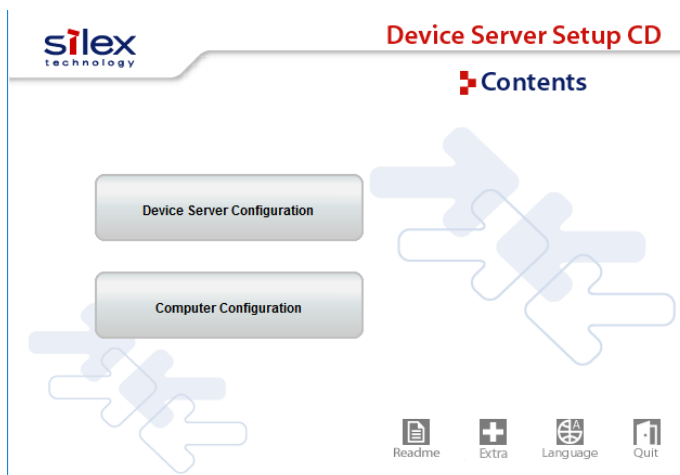

3. Double-click "Cosetup.exe" contained in the "SX Virtual Link Lite" to start the "SX Virtual Link Lite" installer.

4. Select your language and click **Next**.

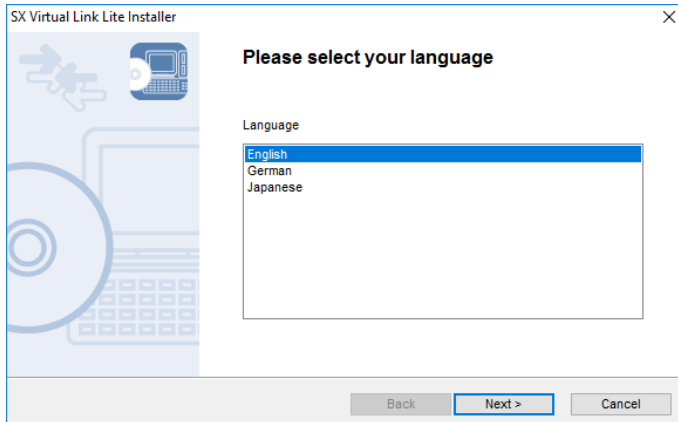

5. SX Virtual Link Lite installation wizard is displayed. Click **Next**.

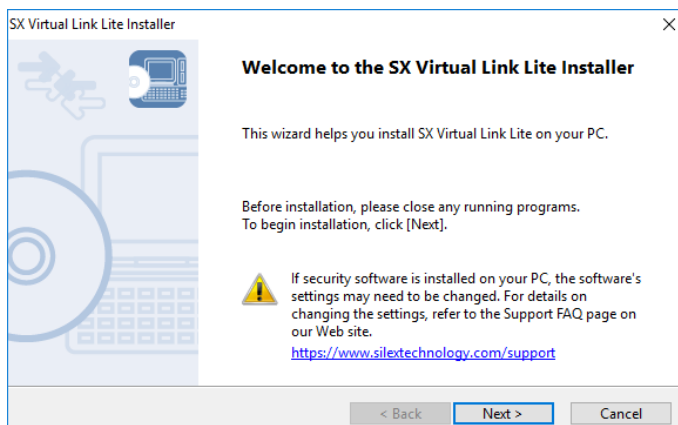

6. Read the **SOFTWARE LICENSE AGREEMENT** and click **Yes**.

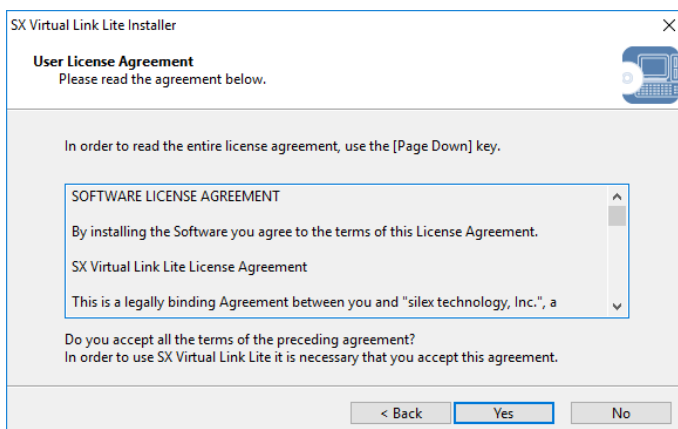

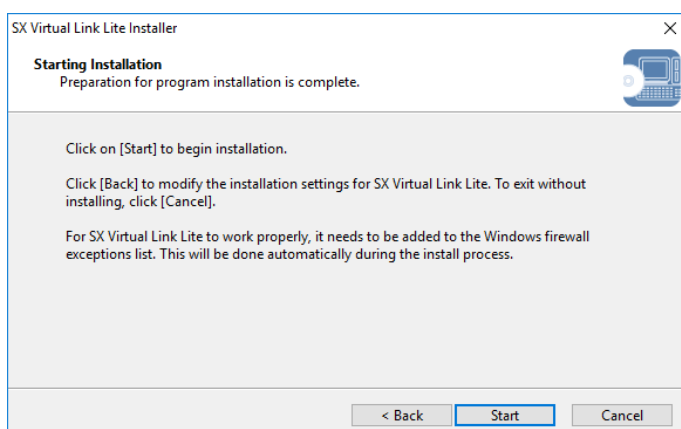
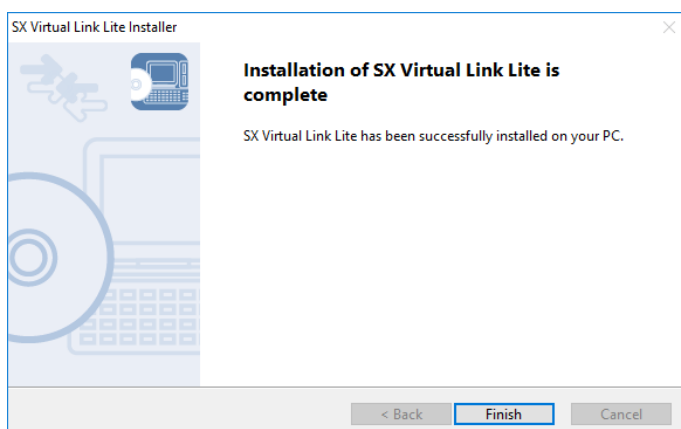
7. Click **Start** to begin the installation.**8.** SX Virtual Link Lite has been installed. Click **Finish**.

8-7-3. SX Virtual Link Lite Setting

This page explains on "SX Virtual Link Lite Setting" that is used to configure the SX Virtual Link Lite settings.

Using SX Virtual Link Lite

SX Virtual Link Lite Setting is used to configure the SX Virtual Link Lite settings. Follow the instructions below to start it.

1. SX Virtual Link Lite Setting starts automatically after it is installed.

**Note**

- Follow the instructions below to start SX Virtual Link Lite Setting manually.

<For Windows 10>

Click **Start - (All Apps) - silex Tools - SX Virtual Link Lite Setting**.

<For Windows 8.1>

Display the app view from start screen and click **SX Virtual Link Lite Setting**.

<For Windows 7>

Click **Start - (All) Programs - silex Tools - SX Virtual Link Lite - SX Virtual Link Lite Setting**.

2. SX Virtual Link Lite Setting's main window appears and device servers and USB devices are shown on it.

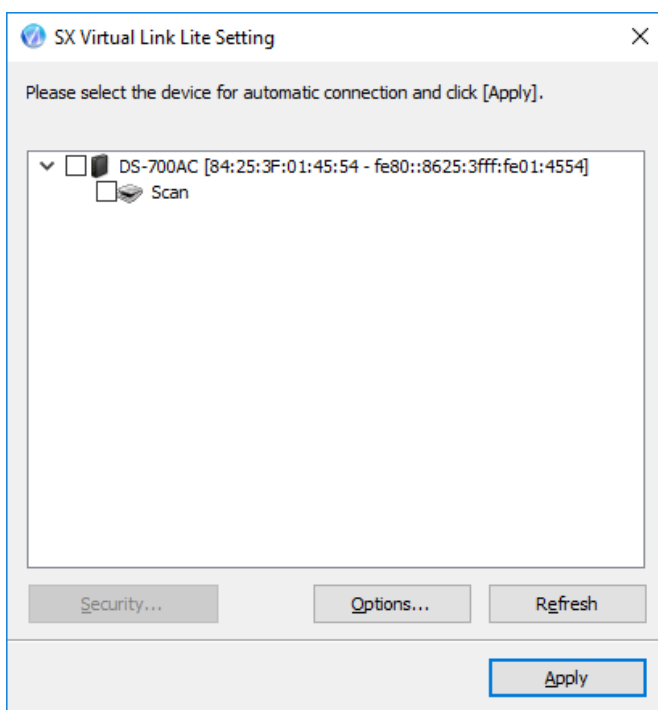

3. Check the check box of the device to connect automatically.

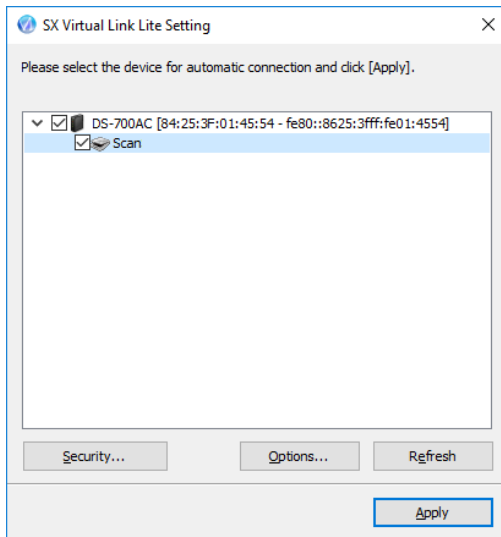

4. Click **Apply**.

5. Click **Yes** in the message below.

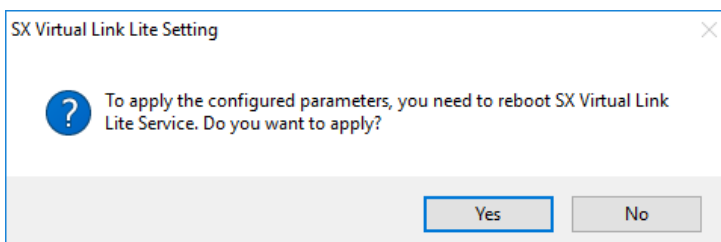

6. The setting will take effect on SX Virtual Link Lite. When it is finished, SX Virtual Link Lite Setting will be closed and the selected USB devices will automatically be connected.

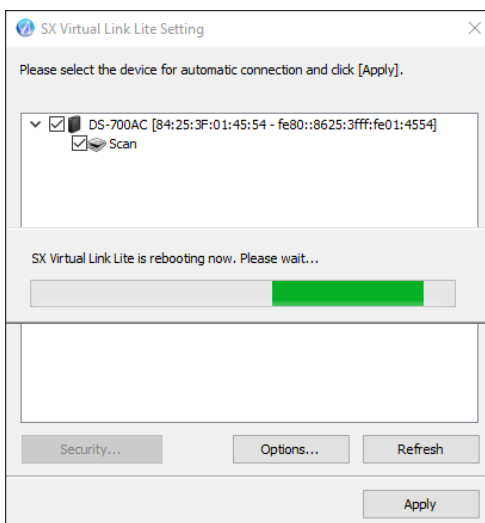

SX Virtual Link Lite Setting's Window

SX Virtual Link Lite Setting's Window

<Main window>

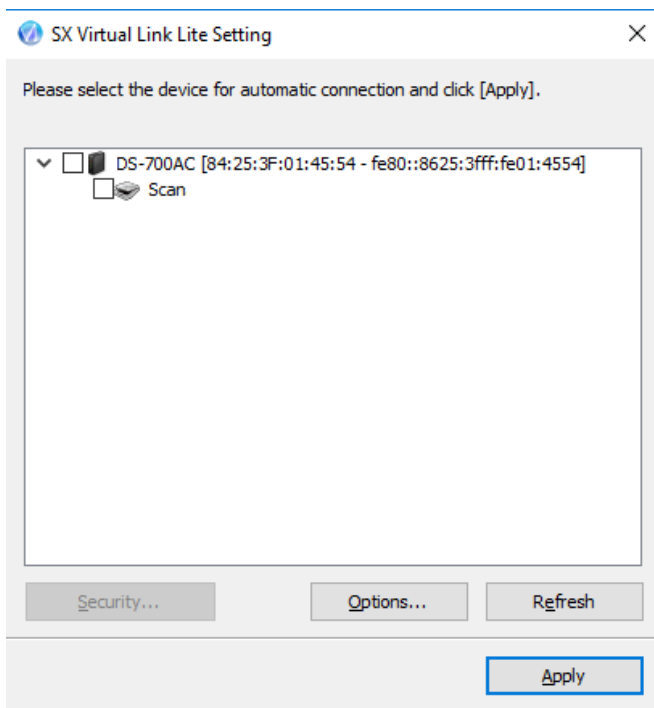

Security	Opens the security dialog. The button is enabled only when the device server supports the USB connection password or encrypted connection.
Options	Opens the option dialog window. Broadcast address can be configured on this window.
Refresh	Refreshes the main window by searching the device servers and the connected devices on network.
Apply	Applies the setting (information of device chosen by user) to SX Virtual Link Lite.

<Options window>

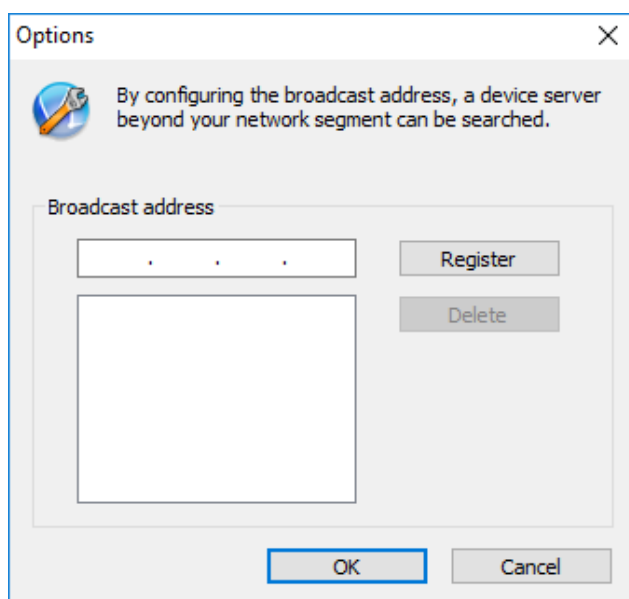

Register	<p>Adds an address to search. Enter the broadcast address to the address field and click Register (up to 16 addresses can be registered).</p> <p>The broadcast address needs to be registered in case you want to search for networks beyond the router. If no broadcast addresses are specified, only device servers in a local segment (network separated by the router) will be searched.</p>
Delete	<p>Removes a registered address. Select the address to remove and click Delete.</p>

8-8. Uninstalling Application on Windows

This page explains how to uninstall SX Virtual Link on Windows.

8-8-1. Uninstalling SX Virtual Link

SX Virtual Link can be uninstalled from **Uninstall a program** in the **Control Panel**.
How to uninstall SX Virtual Link:



- To uninstall SX Virtual Link, administrator privilege is required.

1. Click **Start - (All Apps) - silex Tools**, and right-click on **SX Virtual Link** and click **Uninstall**.

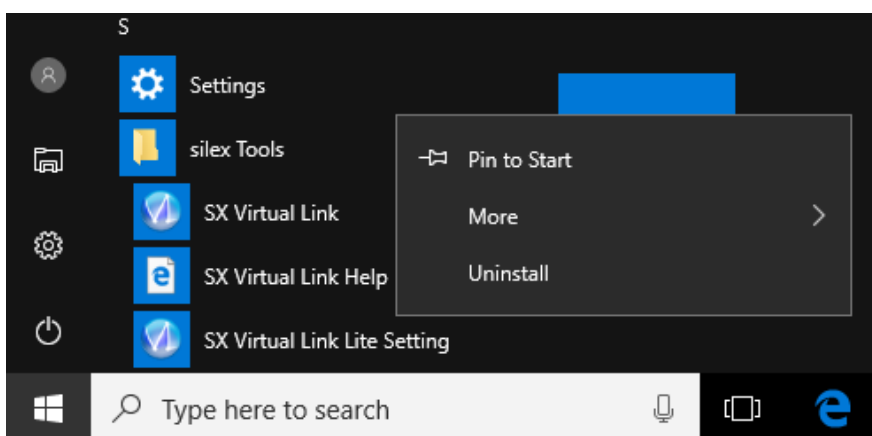

2. Select **SX Virtual Link** from the list and click **Uninstall**.

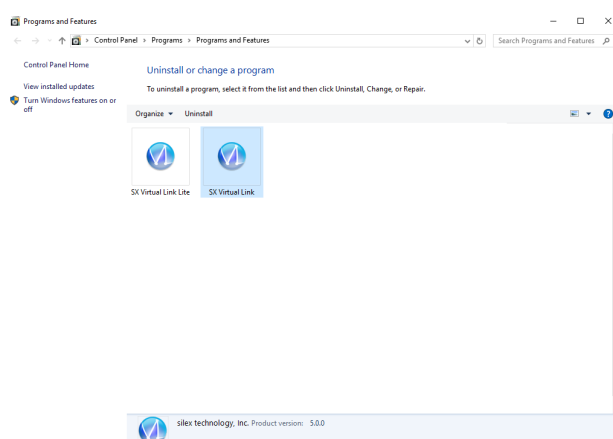

3. A confirmation message is displayed. Click **Yes** to start the uninstallation.

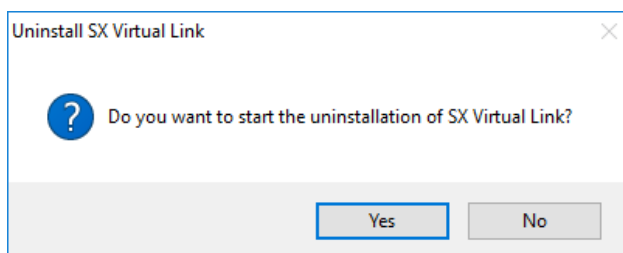

4. When a screen below is displayed, click **Restart**.

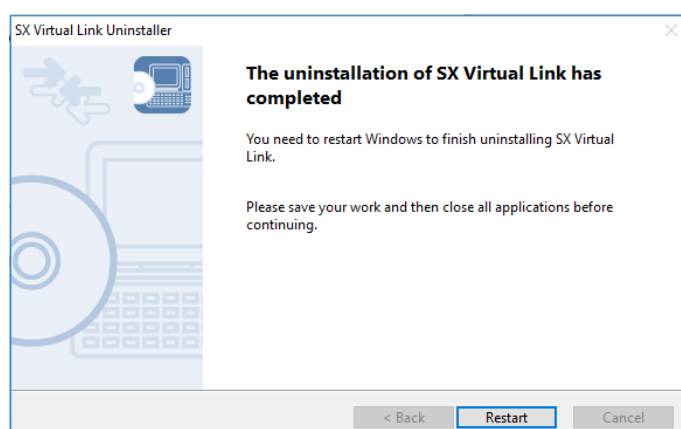

SX Virtual Link has been uninstalled.

8-8-2. Uninstalling SX Virtual Link Lite

SX Virtual Link Lite can be uninstalled from Uninstall a program in the Control Panel. How to uninstall SX Virtual Link Lite:



- To uninstall SX Virtual Link Lite, administrator privilege is required.

1. Click **Start - Control Panel - Uninstall a program**.

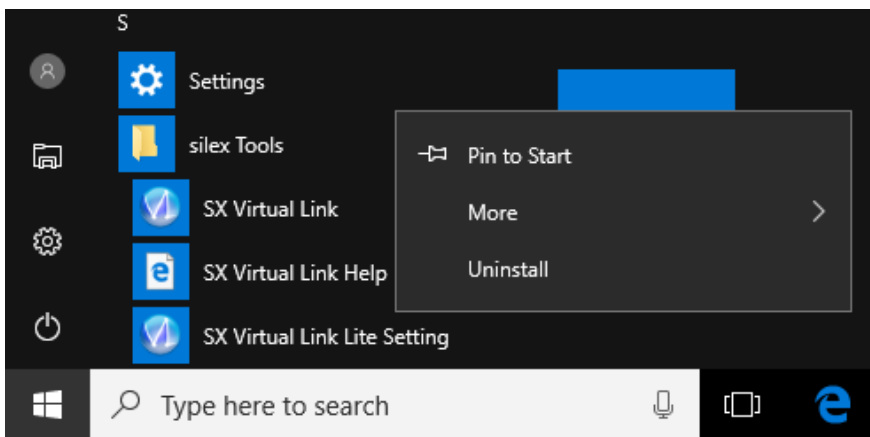

2. Select **SX Virtual Link Lite** from the list and click **Uninstall**.

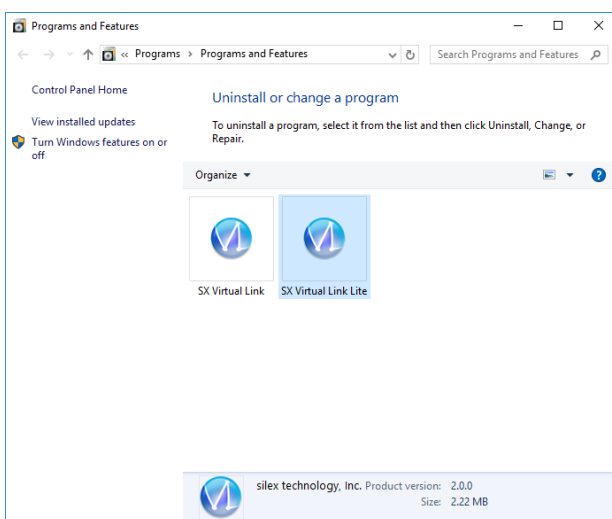

3. A confirmation message is displayed. Click **Yes** to start the uninstallation.

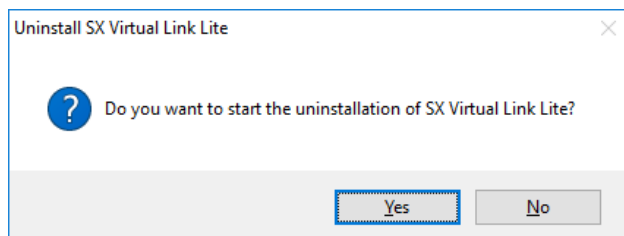

4. When a screen below is displayed, click **Restart**.

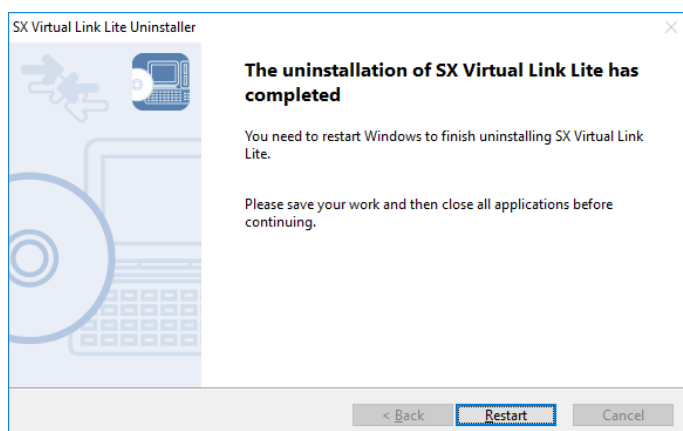

SX Virtual Link has been uninstalled.

Blank page

9. Troubleshooting

9-1. Useful Information

This page contains useful information that can answer your possible questions.

- How can I remove a USB device connected to DS-700AC?

First of all, confirm that the USB device is not currently connected by looking at SX Virtual Link's main window, and then unplug it from DS-700AC. Unplugging the USB device while it is being used might lead to data corruption.

For details on SX Virtual Link, see **7. Using USB Devices Connected to DS-700AC**.

Also, if the connected USB device is a printer, confirm that there are no print jobs being performed. Please remember that the printer may be intended for use with the print server feature, not only by SX Virtual Link.

- Is there anything I should do before connecting a USB device to DS-700AC?

If the driver of the USB device that you wish to use with DS-700AC is not yet installed to your PC, install it first.

For details on how to install the driver, refer to the operating manual of the USB device.

If the USB device requires an external power source, power on the USB device after connecting it to DS-700AC.

- How can I use two or more USB devices?

Two or more USB devices can be connected to DS-700AC by using a USB HUB.

For the maximum number of connectable devices, refer to **2-3-2. Software Specifications**.

However, please note that when two or more USB devices are connected, data transfer speed will decrease.

- How can I get my PC ready to use DS-700AC?

If the driver of the USB device that you wish to use with DS-700AC is not yet installed on your PC, install it first.

For details on how to install the driver, refer to the operating manual of the USB device.

Second, install the necessary application on your PC.

For details, refer to **6. Installing the Application to PC**.

If the setting to restrict a particular PC is enabled on DS-700AC, your PC may not be able to access it.

Please confirm that your PC is not included as a restriction target.

For details on the restriction setting, refer to **8-4-3. Filtering Accesses from a Particular PC**.

- How can I change the DS-700AC's settings?

There are four ways to change the DS-700AC's settings as follows:

Configuration using a network cable

By using a network cable (used to connect DS-700AC to your existing network) and "Device Server Setup" you have downloaded from our website, you can change the settings as you did for the setup.

For details, refer to **5-1. Configuration via a Network Cable (Recommended)**.

Configuration using a Smart Wireless Setup feature of your wireless router

By using WPS of your wireless router, you can change the settings as you did for the setup. For details, refer to **5-2. Configuration via WPS**.

Configuration using a USB flash drive

By using a USB flash drive (used to save configuration information with it) and "Device Server Setup" you have downloaded from our website, you can change the settings as you did for the setup.

For details, refer to **5-3. Configuration via a USB Flash Drive**.

Use the Web page of DS-700AC

The settings can also be changed from the Web page.

For details on the Web page of DS-700AC, refer to **8-1. Using the Web Configuration Page**.

- How can I initialize DS-700AC?

There are two ways to initialize DS-700AC as follows:

Use the push switch on the unit

By using the push switch on the DS-700AC unit, you can reset DS-700AC to its factory default settings.

For the detailed process, refer to **Resetting using the push switch on DS-700AC** at **8-5-2. Resetting to Factory Default**.

Use the Web page of DS-700AC

DS-700AC can also be reset to its factory default settings from the Web page.

For details on the Web page of DS-700AC, refer to **Resetting from the Web page** at **8-5-2. Resetting to Factory Default**.

- What if I use a DS-700AC that has been used in other networks?

If your DS-700AC has been used in other networks, it may contain settings that do not match your new environment.

To use DS-700AC in your new environment, initialize it first and then install and configure it according to the following procedures:

Step 1. **Resetting to Factory Default**

Step 2. **Configuration**

- How can I use the print server feature?

For the print server feature, refer to **8-2. About the Print Server Feature at Other Features.**



- If the IP address of DS-700AC changes while the print server feature (standard Windows printing feature) is used, please also change the printer port setting on Windows, otherwise printing will become unavailable. To avoid this, it is recommended that you set a static IP address to DS-700AC or set your DHCP server to always assign a static address to DS-700AC.

- How can I uninstall the application from my PC?

To uninstall the application from your PC, refer to **8-8. Uninstalling Application on Windows.**

9-2. Q&A

9-2-1. Problems During Setup

This page explains the troubleshooting procedures to resolve problems you may experience while installing DS-700AC.

DS-700AC is not displayed in the search result of the Device Server Setup

When DS-700AC is not displayed in the search result of Device Server Setup, the cause need to be determined from the installation status, network environment, and status of PC used for the configuration of DS-700AC.

DS-700AC or the Ethernet Hub DS-700AC is connected to may have a problem regarding connection, power transmission, or operation.

Solution	Please check the LED status of DS-700AC and the Ethernet Hub DS-700AC is connected to. If the LED indicates improper status, replace the AC plug and other cables, and reboot the connected devices.
----------	--

The startup of DS-700AC may not have been completed.

Solution	It takes up to 30sec for DS-700AC to get ready after it is powered on. Please wait until DS-700AC becomes ready and then click the Search in the Device Server Setup.
----------	---

DS-700AC may not be in the same network segment (environment without a router) as your PC.

Solution	During the initial configuration, place DS-700AC and PC in the same network segment.
----------	--

If DS-700AC has been used in another network, it may have the settings not allowing the communication with your PC.

Solution	Please reset DS-700AC to the factory default setting. Refer to Resetting to 8-5-2. Resetting to Factory Default for details.
----------	---

Security software such as firewall may be interrupting the communication with DS-700AC.

Solution	Please abort your security software. Refer to FAQ in our website (https://www.silxtechnology.com/) for details on how to abort security software.
----------	---

Communication error occurs when configuring with Device Server Setup.

When a communication error occurs during Device Server Setup, the cause needs to be determined from the settings of the PC used for the configuration.

DS-700AC may not be in the same network segment (environment without a router) as your PC.

Solution	During the initial configuration, place DS-700AC and PC in the same network segment.
----------	--

In the environment where there is DHCP server, the DHCP server may have configured the IP address of the different segment to a PC.

Solution	Please select Obtain an IP address automatically at Internet Protocol (TCP/IP) Properties of the PC. Otherwise connect the PC and DS-700AC with a crossover cable or to the standalone Ethernet Hub and see how it works.
----------	---

If DS-700AC has been used in another network, it may have the settings not allowing the communication with your PC.

Solution	Please reset DS-700AC to the factory default setting. Refer to Resetting to 8-5-2. Resetting to Factory Default for details.
----------	---

How should I determine the way to assign an IP address to DS-700AC?

There are two ways to assign an IP address to DS-700AC; one is to **Get IP address automatically from DHCP server** and the other is to **Assign IP address manually**. Choose the way to assign an IP address according to your environment.

When there is a DHCP server in the network environment

Solution	You can use Get IP address automatically from DHCP server. As DS-700AC is set by default to Get IP address automatically, DS-700AC will obtain an IP address appropriate to your network environment from the DHCP server just by powering up DS-700AC. Refer to 8-5-2. Resetting to Factory Default for details on how to reset DS-700AC to the factory default settings.
----------	--

When there is no DHCP server in the network environment, or when you do not prefer getting an IP address from DHCP server

Solution	<p>Please use DHCP Server feature of DS-700AC or Assign IP address manually. Keep in mind of the following points regarding the IP address to assign to DS-700AC.</p> <ul style="list-style-type: none"> - Assign an IP address unique in the network. - Assign an IP address that has the same address class as the PC that will use DS-700AC. e.g. When an IP address of the PC is "192.168.0.xx", assign an address such as "192.168.0.100" that is not used by other network devices. <p>(Tips about the IP address)</p> <ul style="list-style-type: none"> - An IP address is a unique number for identifying network devices. An IP address is indicated with four numbers divided by a period (.), for example "192.168.0.1". The integer from 0-255 is used for each number. - An IP address is, depending on the number assigned, categorized to 3 classes below. - Numbers making up the IP address are either network numbers indicating network, or host numbers indicating each network device; each number indicates the different meaning based on the IP address class. Each class is categorized as the following diagram which is indicating a network number as n, and a host number as u. An IP address with the same network number must be assigned to the network devices in the same network segment. - There is an address range in the IP address called the private address that could be used freely. In the LAN environment not directly connected to the internet, an IP address is assigned within the range of the private address. 																			
	<table border="1"> <thead> <tr> <th>First 1 digits in IP address</th> <th>Class</th> <th>Definition of IP address n: network number u: host number</th> <th>Size of the network to be used</th> <th>Private address</th> </tr> </thead> <tbody> <tr> <td>0~127</td> <td>A</td> <td>n.u.u.u</td> <td>Large network</td> <td>10.0.0.0 ~ 10.255.255.255</td> </tr> <tr> <td>128~191</td> <td>B</td> <td>n.n.u.u</td> <td>Mid-size network</td> <td>172.16.0.0 ~172.31.255.255</td> </tr> <tr> <td>192~223</td> <td>C</td> <td>n.n.n.u</td> <td>Small network</td> <td>192.168.0.0 ~192.168.255.255</td> </tr> </tbody> </table>	First 1 digits in IP address	Class	Definition of IP address n: network number u: host number	Size of the network to be used	Private address	0~127	A	n.u.u.u	Large network	10.0.0.0 ~ 10.255.255.255	128~191	B	n.n.u.u	Mid-size network	172.16.0.0 ~172.31.255.255	192~223	C	n.n.n.u	Small network
First 1 digits in IP address	Class	Definition of IP address n: network number u: host number	Size of the network to be used	Private address																
0~127	A	n.u.u.u	Large network	10.0.0.0 ~ 10.255.255.255																
128~191	B	n.n.u.u	Mid-size network	172.16.0.0 ~172.31.255.255																
192~223	C	n.n.n.u	Small network	192.168.0.0 ~192.168.255.255																

9-2-2. Problems While Using DS-700AC

This page explains the troubleshooting procedures to resolve problems you may experience while using DS-700AC.

The USB device is not displayed in SX Virtual Link.

If the USB device is not displayed in SX Virtual Link, you need to check the cable connection as well as the network settings between DS-700AC and your PC.

DS-700AC or the Ethernet Hub DS-700AC is connected to may have a problem regarding connection, power transmission, or operation.

Solution	Please check the LED status of DS-700AC and the Ethernet Hub DS-700AC is connected to. If the LED indicates improper status, replace the AC plug and other cables, and reboot the connected devices.
----------	--

The startup of DS-700AC may not have been completed.

Solution	It takes up to 30sec for DS-700AC to get ready after it is powered on. Please wait until DS-700AC becomes ready and then click the Refresh button  in SX Virtual Link again.
----------	---

Security software such as firewall may be interrupting the communication with DS-700AC.

Solution	Please add SX Virtual Link to the exception list in your security software. Please refer to the FAQ on our website (https://www.silextechnology.com/) for details on adding an application to the exception list.
----------	--

An IP address unable to communicate with your PC may be assigned to DS-700AC.

Solution

First, check the IP Address of your PC.
To check the IP Address, use the Windows Command Prompt.

1. Select **Start - All Programs - Windows System - Command Prompt**.
2. When the Command Prompt is started, execute the **ipconfig** command.

Example of executing the ipconfig command

```
Microsoft Windows [Version 6.1.7601]
(C) Copyright (c) 2009 Microsoft Corporation. All right reserved.
```

```
C:\Users\username>ipconfig (Press Enter)
```

```
Windows IP Configuration
```

```
Ethernet adapter Local Area Connection:
```

```
Connection-specific DNS Suffix . . . :
IPv6 Address . . . . . : 2001:db8::x:x:x
Temporary IPv6 Address. . . . . : 2001:db8::z:z:z
Link-local IPv6 Address . . . . . : fe80::x:x:x%4
IPv4 Address . . . . . : 192.168.0.10 (IP address of PC)
Subnet Mask . . . . . : 255.255.255.0
Default Gateway . . . . . : fe80::x%4
                             192.168.0.254
```

Check that the IP Address of the PC is a proper address for communicating with the IP Address of DS-700AC.

If the PC and DS-700AC are in the same network segment but use a different network number in their addresses, you need to change either the address of the PC or DS-700AC. Also, if there is a router between the PC and DS-700AC, check that the default gateway address is properly configured.

The IP address assigned to the DS-700AC may be in use by another network device.	
Solution	<p>First, turn off DS-700AC and open the Windows Command Prompt. Ping the IP address of DS-700AC.</p> <ol style="list-style-type: none"> 1. Select Start - All Programs - Windows System - Command Prompt. 2. When the Command Prompt appears, execute the ping command. <p>Example of executing the ping command when the IP address of DS-700AC is 192.168.0.20</p> <div style="background-color: black; color: white; padding: 10px;"> <pre> Microsoft Windows [Version 6.1.7601] (C) Copyright (c) 2009 Microsoft Corporation. All right reserved. C:\Users\username>ping 192.168.0.20 (Press Enter) Pinging 192.168.0.20 with 32 bytes of data: (When there is reply) Reply from 192.168.0.20: bytes=32 time<1ms TTL=128 Reply from 192.168.0.20: bytes=32 time<1ms TTL=128 Reply from 192.168.0.20: bytes=32 time<1ms TTL=128 Reply from 192.168.0.20: bytes=32 time<1ms TTL=128 (When there is no reply) Reply from 192.168.0.10: Destination host unreachable Reply from 192.168.0.10: Destination host unreachable Reply from 192.168.0.10: Destination host unreachable Reply from 192.168.0.10: Destination host unreachable </pre> </div> <p>If there is a reply while DS-700AC is turned off, it means there is another network device using the same IP address as DS-700AC. In such a case, change the IP address of either DS-700AC or the other network device.</p>

The USB device connected to DS-700AC may not be powered on.	
Solution	<p>Check the LEDs on the USB device to see if it is powered on. If the USB device is not powered on, confirm the AC adaptor is connected properly.</p> <p>Also, if the USB device is a bus-powered device, it may require power exceeding the maximum power capability of DS-700AC (e.g. HDD drive, etc.). In that case, please use the AC adaptor bundled with the USB device.</p>

Power supply to the USB port may have been cut off due to an overcurrent detected by the overcurrent protection feature.

Solution	<p>Please see the Web page of DS-700AC.</p> <p>If the message "An over-current was detected and the USB port shut down. Please reboot the device server." is displayed, Bus power has been cut off.</p> <p>In such a case, unplug all USB devices from DS-700AC and reboot it.</p> <p>If you are using USB devices that run on USB Bus power, it is recommended to avoid using two or more devices at once, so that the total power used does not exceed the maximum power capability of DS-700AC.</p>
----------	--

A USB cable used to connect DS-700AC and USB devices may not be plugged in correctly.

Solution	<p>Please confirm the proper cable connection between DS-700AC and the USB devices. If there is a spare USB cable, replace the cable and see how it works.</p>
----------	--

An error occurs after USB device is connected using SX Virtual Link.

When USB devices are properly displayed in SX Virtual Link but an error occurs when they are connected, you need to check the USB device specification as well as the PC settings.

Software required to work the USB device (device driver) may not have been installed correctly.

Solution	<p>Please connect the USB device directly to your PC and see how it works. If the USB device still does not work properly, the device driver may not have been installed to your PC correctly. See the operation manual that came with the USB device and re-install the device driver again.</p>
----------	---

DS-700AC does not switch to ECO Mode even though the specified time period has passed.

ECO Mode may not be enabled.

Solution	<p>Please make sure that the "Power Save Mode " setting is set to ENABLE.</p> <p>For details on the ECO Mode setting, refer to 8-5-1. About ECO Mode.</p>
----------	---

SX Virtual Link may be running on the network DS-700AC is connected to.

Solution	<p>Because SX Virtual Link regularly communicates with DS-700AC, DS-700AC will not switch to ECO Mode if SX Virtual Link is running.</p> <p>To allow DS-700AC to switch to ECO Mode, shut down all PCs with SX Virtual Link installed or close SX Virtual Link on each PC. For details, refer to 8-5-1. About ECO Mode.</p>
----------	--

Printing using the print server feature does not function.

The IP address of DS-700AC may have changed.	
Solution	When the IP address of DS-700AC changes, please also change the corresponding printer port setting on Windows. When using the print server feature, it is recommended that you set a static IP address to DS-700AC or set your DHCP server to always assign a static address to DS-700AC.

The USB port your printer is connected to may have been changed while DS-700AC is running in ECO Mode.	
Solution	Please restart DS-700AC if you have changed the USB port your printer is connected to while in ECO Mode.

Frame dropping or sound skipping occurs when I use a Web camera or USB speaker.

The USB device may not be directly connected to DS-700AC.	
Solution	When you use isochronous devices such as Web camera, USB speaker, etc, please connect them directly to DS-700AC.

You may be using DS-700AC on a 100BASE-TX/10BASE-T network.	
Solution	For isochronous devices such as Web cameras or USB speakers, etc, it is recommended to use a Gigabit Ethernet network.

DS-700AC can be connected via a wired network but not via a wireless network.

The operation mode or settings of DS-700AC may need to be checked.	
Solution	If the Network Mode is set to AUTO , DS-700AC will run in wired LAN mode when a network cable is connected. Unplug the network cable and restart DS-700AC to use DS-700AC on a wireless LAN. If the Network Mode is set to Wired , DS-700AC will run in wired LAN mode. Please confirm that the Network Mode is properly configured.

The wireless settings configured for DS-700AC may not be appropriate for your environment.	
Solution	Connect a network cable to DS-700AC and check the wireless settings of DS-700AC via a wired network.

Connection is interrupted or disconnected.

If your wireless LAN is interrupted or disconnected, DS-700AC may be placed in a location subject to weaker radio wave signals.

Solution	Reconsider the location and surrounding conditions. Please try to use DS-700AC in a room with better sight and radio signal strength.
----------	--

Wireless transmission speed is too slow or a wireless link cannot be made.

Wireless transmission speed is too slow or a wireless link cannot be made.

DS-700AC may be placed in a location subject to weaker radio wave signals.

Solution	Move DS-700AC closer to your wireless router. If there is an obstacle between them, remove it. Please try to use DS-700AC in a room with better sight and radio signal strength.
----------	---

There are two or more neighboring network groups and similar channel frequency is used by them.

Solution	If there are two or more neighboring wireless network groups, keep 5 or more channels between each group. Example: If group 1 uses channel 1, group 2 should use channel 6 or higher.
----------	--

There is an electrical device such as a microwave, etc. near DS-700AC which affects the communication.

Solution	Reconsider the location and surrounding conditions.
----------	---

Blank page