

An aerial night view of a city with a network overlay. The city is illuminated with blue and white lights, and a complex network of glowing blue lines and nodes is superimposed over the scene, representing a global communication network. The background is dark, making the city lights and network nodes stand out.

QUECTEL

Quectel BG95&BG77&BG600L Series LPWA Module

Introduction

Build a Smarter World



Duty of Confidentiality

The Receiving Party shall keep confidential all documentation and information provided by Quectel, except when the specific permission has been granted by Quectel. The Receiving Party shall not access or use Quectel's documentation and information for any purpose except as expressly provided herein. Furthermore, the Receiving Party shall not disclose any of the Quectel's documentation and information to any third party without the prior written consent by Quectel. For any noncompliance to the above requirements, unauthorized use, or other illegal or malicious use of the documentation and information, Quectel will reserve the right to take legal action.

Build a Smarter World

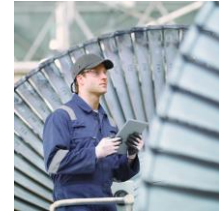
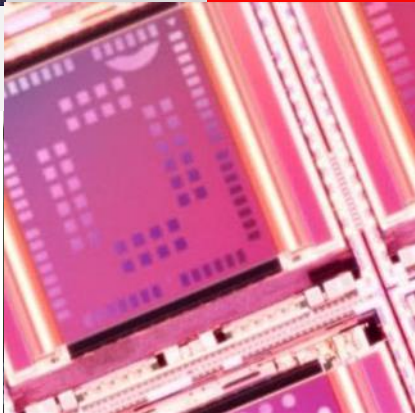
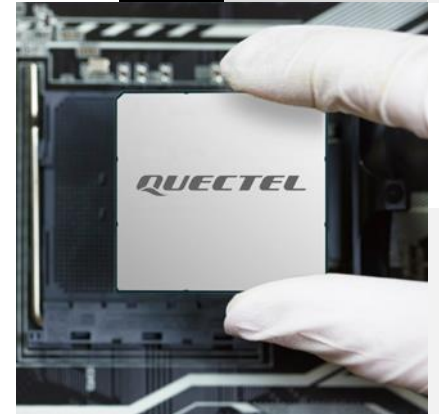



Technical Background

LPWA Module Portfolio
Highlights & Specifications
Development Timeline
Technical Details
Applications
Appendix

Build a Smarter World

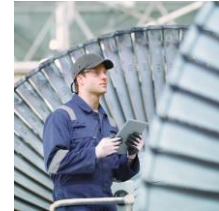
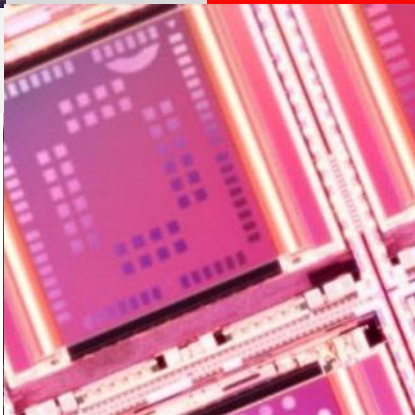
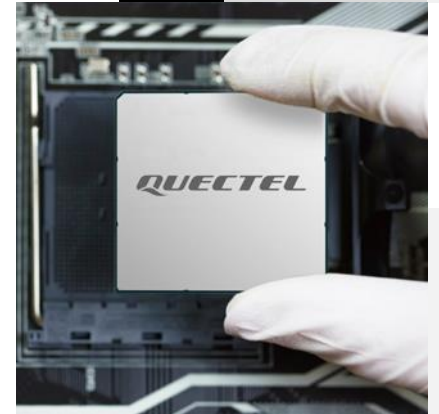

LPWA Technical Advantages

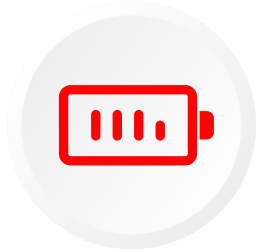

Low Power Consumption

- NB: 0.8 μ A (Typ.) @ PSM
- Cat M: 3.9 μ A (Typ.) @ PSM
- eDRX Technology



Massive Connection

- Ideal connection to about 50,000 devices per cell
- Optimized spectral efficiency



Cost Effective

- The simplest hardware cellular technology
- Low data charge fees



Extended Network Coverage

- 20 dB link budget enhancement
- Repetition/ retransmission mechanism
- Signal through-wall, deep indoor coverage

LPWA Connectivity Growth Trend

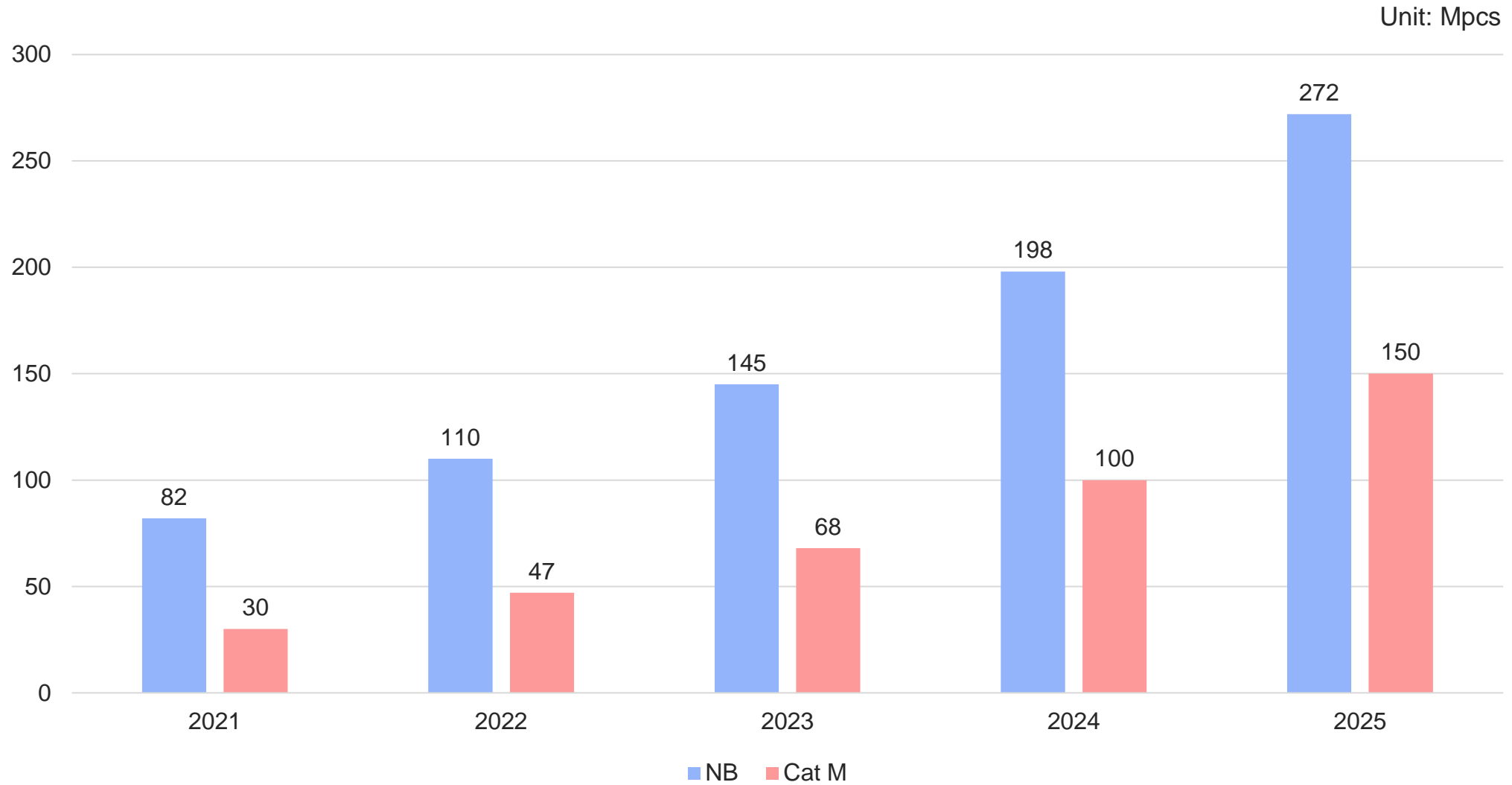

Source: ABI Research.

LPWA Network Deployment



Mobile IoT Global Coverage	
Cat M & NB	NB

Note:
 1. Information sourced from GSMA and revised by Quectel, updated on Mar, 2022
 2. For more operator deployment details, please refer to [Appendix](#)



Technical Background

LPWA Module Portfolio

Highlights & Specifications

Development Timeline

Technical Details

Applications





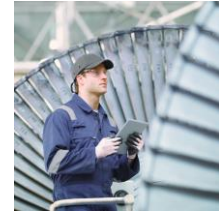
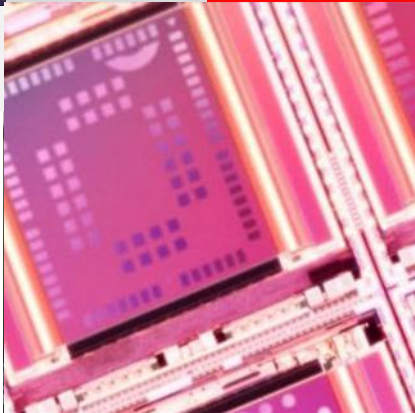
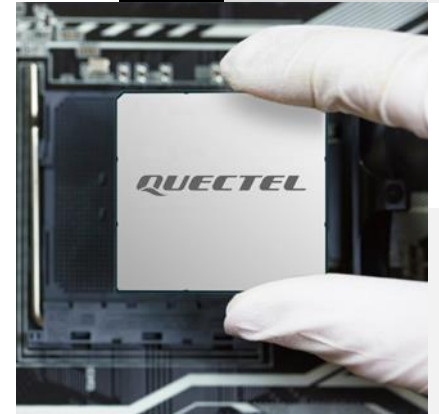





Appendix

Build a Smarter World



LPWA Module Portfolio



	BG95 Series	BG77	BG600L	
MDM9205	 <p>BG95-M1</p> <ul style="list-style-type: none"> • Cat M • Best Cost for Cat M Only • Power Class 5 	 <p>BG95-M2</p> <ul style="list-style-type: none"> • Cat M/ NB • Cost Efficient • Power Class 5 		
	 <p>BG95-M3</p> <ul style="list-style-type: none"> • Cat M/ NB/ EGPRS • Mainstream Option • Power Class 5 	 <p>BG95-M4</p> <ul style="list-style-type: none"> • Cat M/ NB • 450 MHz (B31/ 72/ 73) • Power Class 5 		
	 <p>BG95-M5</p> <ul style="list-style-type: none"> • Cat M/ NB/ EGPRS • Power Class 3 	 <p>BG95-M6</p> <ul style="list-style-type: none"> • Cat M/ NB • Power Class 3 		
	 <p>BG95-MF</p> <ul style="list-style-type: none"> • Cat M/ NB • Wi-Fi Positioning • Power Class 5 	 <p>BG95-M9</p> <ul style="list-style-type: none"> • Cat M/ NB • 450 MHz (B31/ 72/ 73) • Power Class 3 		
			 <p>BG77</p> <ul style="list-style-type: none"> • Cat M/ NB • Super Compact Size • Power Class 5 	
				 <p>BG600L-M3</p> <ul style="list-style-type: none"> • Cat M/ NB/ EGPRS • Compact Tri-Mode Module • Power Class 5



Technical Background
LPWA Module Portfolio

Highlights & Specifications

Development Timeline
Technical Details
Applications
Appendix

Build a Smarter World

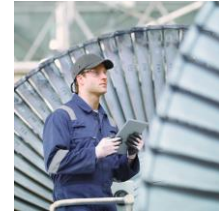
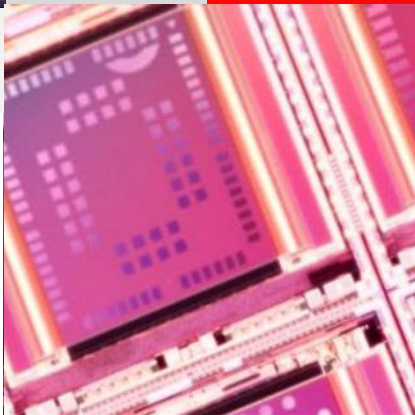
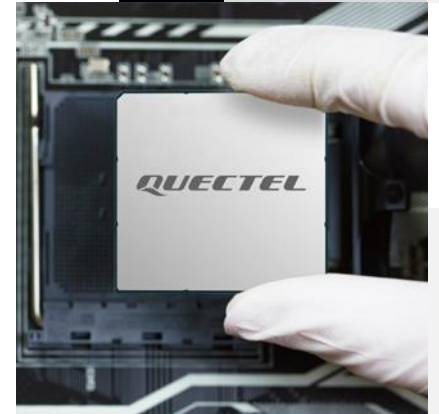

BG95 Series Highlights



Global certification:
Covering world's different regions.



Classic Form Factor: 23.6 × 19.9 × 2.2 mm



Enhanced features:
Such as DFOTA, GNSS, VoLTE, QuecOpen®.

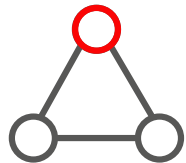

Large market share:
Hundreds of millions of modules deployed in the market.

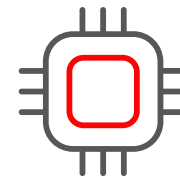

Mature platform:
Qualcomm MDM9205 based.

BG95 Series Specifications



Variant	BG95-M1	BG95-M2	BG95-M3	BG95-M4	BG95-M5	BG95-M6	BG95-MF	BG95-M9
Cat M Band	B1/ 2/ 3/ 4/ 5/ 8/ 12/ 13/ 18/ 19/ 20/ 25/ 26/ 27/ 28/ 66/ 85	B1/ 2/ 3/ 4/ 5/ 8/ 12/ 13/ 18/ 19/ 20/ 25/ 26/ 27/ 28/ 66/ 85	B1/ 2/ 3/ 4/ 5/ 8/ 12/ 13/ 18/ 19/ 20/ 25/ 26/ 27/ 28/ 66/ 85	B1/ 2/ 3/ 4/ 5/ 8/ 12/ 13/ 18/ 19/ 20/ 25/ 26/ 27/ 28/ 31/ 66/ 72/ 73/ 85	B1/ 2/ 3/ 4/ 5/ 8/ 12/ 13/ 18/ 19/ 20/ 25/ 26/ 27/ 28/ 66/ 85	B1/ 2/ 3/ 4/ 5/ 8/ 12/ 13/ 18/ 19/ 20/ 25/ 26/ 27/ 28/ 66/ 85	B1/ 2/ 3/ 4/ 5/ 8/ 12/ 13/ 18/ 19/ 20/ 25/ 26/ 27/ 28/ 66/ 85	B1/ 2/ 3/ 4/ 5/ 8/ 12/ 13/ 18/ 19/ 20/ 25/ 26/ 27/ 28/ 31/ 66/ 72/ 73/ 85/ 87/ 88
NB Band	-	B1/ 2/ 3/ 4/ 5/ 8/ 12/ 13/ 18/ 19/ 20/ 25/ 28/ 66/ 71/ 85	B1/ 2/ 3/ 4/ 5/ 8/ 12/ 13/ 18/ 19/ 20/ 25/ 28/ 66/ 71/ 85	B1/ 2/ 3/ 4/ 5/ 8/ 12/ 13/ 18/ 19/ 20/ 25/ 28/ 31/ 66/ 72/ 73/ 85	B1/ 2/ 3/ 4/ 5/ 8/ 12/ 13/ 18/ 19/ 20/ 25/ 28/ 66/ 71/ 85	B1/ 2/ 3/ 4/ 5/ 8/ 12/ 13/ 18/ 19/ 20/ 25/ 28/ 66/ 71/ 85	B1/ 2/ 3/ 4/ 5/ 8/ 12/ 13/ 18/ 19/ 20/ 25/ 28/ 66/ 71/ 85	B1/ 2/ 3/ 4/ 5/ 8/ 12/ 13/ 18/ 19/ 20/ 25/ 28/ 31/ 66/ 72/ 73/ 85/ 86/ 87/ 88
EGPRS Band	-	-	Quad-band	-	Quad-band	-	-	-
Power Class	Power Class 5	Power Class 5	Power Class 5	<ul style="list-style-type: none"> Power Class 2 @ B31/ 72/ 73 Power Class 5 @ Other Bands 	Power Class 3	Power Class 3	Power Class 5	<ul style="list-style-type: none"> Power Class 2 @ B31/ 72/ 73 Power Class 3 @ Other Bands
Supply Voltage	2.6–4.8 V, Typ. 3.3 V	2.6–4.8 V, Typ. 3.3 V	3.3–4.3 V, Typ. 3.8 V	3.2–4.2 V, Typ. 3.8 V	3.3–4.3 V, Typ. 3.8 V	3.3–4.3 V, Typ. 3.8 V	3.3–4.3 V, Typ. 3.8 V	3.2–4.2 V, Typ. 3.8 V
Power Consumption	4 µA @ PSM	3.9 µA @ PSM	3.9 µA @ PSM	4 µA @ PSM	6 µA @ PSM	5 µA @ PSM	4 µA @ PSM	4.4 µA @ PSM
Positioning	<ul style="list-style-type: none"> GNSS^① QuecLocator[®] 	<ul style="list-style-type: none"> GNSS^① QuecLocator[®] 	<ul style="list-style-type: none"> GNSS^① QuecLocator[®] 	<ul style="list-style-type: none"> GNSS^① QuecLocator[®] 	<ul style="list-style-type: none"> GNSS^① QuecLocator[®] 	<ul style="list-style-type: none"> GNSS^① QuecLocator[®] 	<ul style="list-style-type: none"> GNSS^① QuecLocator[®] 2.4G Wi-Fi Positioning 	<ul style="list-style-type: none"> GNSS^① QuecLocator[®]
Protocol	PPP/ TCP/ UDP/ SSL/ TLS/ FTP(S)/ HTTP(S)/ NITZ/ PING/ MQTT/ LwM2M/ CoAP/ IPv6/ SMS							
Hardware Interface	USB2.0/ PCM/ I2C/ ADC/ UART/ GPIO/ GRFC ^② (Antenna Tuner)/ (U)SIM							
Special Feature	<ul style="list-style-type: none"> VoLTE for Cat M/ CS Voice for GSM nuSIM*/ eSIM/ SoftSIM Jamming Detection Fast Shutdown QuecPython[®] QuecOpen[®]: Integrated ARM Cortex A7 processor supporting ThreadX 							
Certification	All Major Global Carriers ^③						Major Global Carriers	Major Global Carriers
Project Stage	MP	MP	MP	MP	MP	MP	MP	ES

* : Under development/ ongoing ①: BG95 series does not support concurrent operation of WWAN (Wireless Wide Area Network) and GNSS

②: BG95-M4 and BG95-M9 do not support GRFC

③: For TX1.0 versions

BG95 Series Completed Certifications (TX1.0 R02Axx)



BG95-M1

Carrier Certification

Deutsche Telekom/ Verizon/ AT&T/ Sprint/ U.S. Cellular

Regulatory Certification

GCF/ CE/ PTCRB/ FCC/ UKCA/ IC/ JATE/ TELEC/ RCM

BG95-M2

Carrier Certification

Vodafone/ Deutsche Telekom/ Verizon/ AT&T (FirstNet)/ T-Mobile/ Sprint/
U.S. Cellular/ Telus

Regulatory Certification

GCF/ CE/ PTCRB/ FCC/ UKCA/ IC/ Anatel/ IFETEL/ JATE/ TELEC/ RCM/
IMDA/ ATEX

BG95-M3

Carrier Certification

Vodafone/ Deutsche Telekom/ Telefónica/ Orange/ Verizon/ AT&T
(FirstNet)/ T-Mobile/ Sprint/ U.S. Cellular/ Rogers/ Telus/ Claro

Regulatory Certification

GCF/ CE/ PTCRB/ FCC/ UKCA/ IC/ Anatel/ IFETEL/ JATE/ TELEC/ PEN/
CCC/ NCC/ RCM

BG95-M4

Carrier Certification

Deutsche Telekom

Regulatory Certification

GCF/ CE/ Anatel/ RCM

BG95-M5

Carrier Certification

Vodafone/ Deutsche Telekom/ Verizon/ AT&T/ T-Mobile/ NTT DOCOMO/
KDDI/ Telstra/ Rogers

Regulatory Certification

GCF/ CE/ PTCRB/ FCC/ UKCA/ IC/ Anatel/ KC/ JATE/ TELEC/ RCM

BG95-M6

Carrier Certification

Vodafone/ Deutsche Telekom/ Verizon/ AT&T/ T-Mobile/ KT/ SKT/ LGU+/
NTT DOCOMO/ KDDI/ Telstra

Regulatory Certification

GCF/ CE/ PTCRB/ FCC/ UKCA/ IC/ KC/ JATE/ TELEC/ RCM/ Anatel

BG77 & BG600L-M3 Highlights



Global certification:
Covering world's different regions.

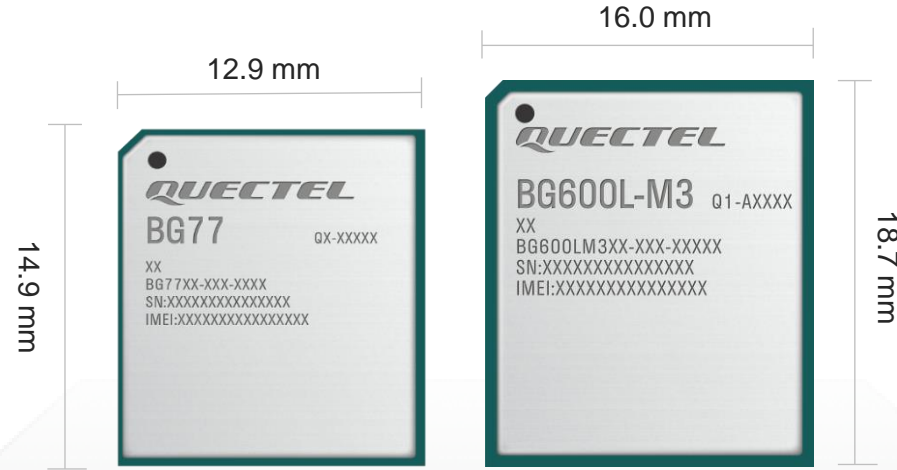

Classic Form Factor: 14.9 × 12.9 × 1.7 mm (BG77)
18.7 × 16.0 × 2.1 mm (BG600L-M3)



Enhanced features:
Such as DFOTA, GNSS, fast shut down, QuecOpen®, jamming detection.

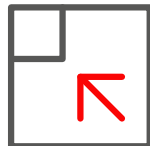

Small size:
Applicable to size-sensitive devices.

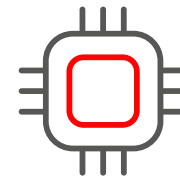

Mature platform:
Qualcomm MDM9205 based.

BG77 & BG600L-M3 Specifications



Module		BG77	BG600L-M3
Cat M Band		B1/ 2/ 3/ 4/ 5/ 8/ 12/ 13/ 18/ 19/ 20/ 25/ 26/ 27/ 28/ 66/ 85*	B1/ 2/ 3/ 4/ 5/ 8/ 12/ 13/ 18/ 19/ 20/ 25/ 26/ 27/ 28/ 66/ 85
NB Band		B1/ 2/ 3/ 4/ 5/ 8/ 12/ 13/ 18/ 19/ 20/ 25/ 28/ 66/ 71/ 85*	B1/ 2/ 3/ 4/ 5/ 8/ 12/ 13/ 18/ 19/ 20/ 25/ 28/ 66/ 71/ 85
EGPRS Band		-	Quad-band
Power Class		Power Class 5	Power Class 5
Supply Voltage		2.6–4.8 V, Typ. 3.3 V	3.3–4.3 V, Typ. 3.8 V
Power Consumption		3.44 μ A @ PSM	4.0 μ A @ PSM
Voice		VoLTE for Cat M	VoLTE for Cat M & CS Voice for GSM
Positioning		GNSS & QuecLocator®	GNSS & QuecLocator®
Protocols		PPP/ TCP/ UDP/ SSL/ TLS/ FTP(S)/ HTTP(S)/ NITZ/ PING/ MQTT/ LwM2M/ CoAP/ IPv6/ SMS	
Hardware Interface		USB 2.0/ PCM/ I2C/ ADC/ UART/ GPIO/ GRFC(Antenna Tuner)/ (U)SIM	
Special Feature		<ul style="list-style-type: none"> • Jamming Detection • Fast Shutdown • SoftSIM • QuecOpen®: Integrated ARM Cortex A7 processor supporting ThreadX 	
Certification ^①	Carrier	Vodafone/ Deutsche Telekom/ Verizon/ AT&T/ T-Mobile / Sprint/ U.S. Cellular	Vodafone/ Deutsche Telekom/ T-Mobile
	Regulatory	GCF/ CE/ PTCRB/ FCC/ UKCA/ IC/ NCC/ JATE/ TELEC/ RCM	GCF/ CE/ PTCRB/ FCC/ UKCA/ IC/ RCM/ Anatel
Project Stage		MP	MP

* : Under development ①: For TX1.0 versions



Technical Background

LPWA Roadmap

Highlights & Specifications

Development Timeline

Technical Details

Applications

Appendix

Build a Smarter World

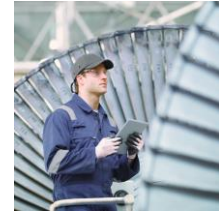
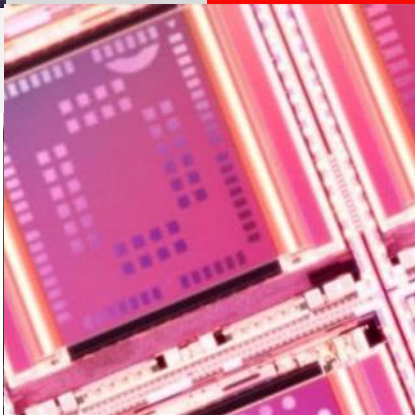
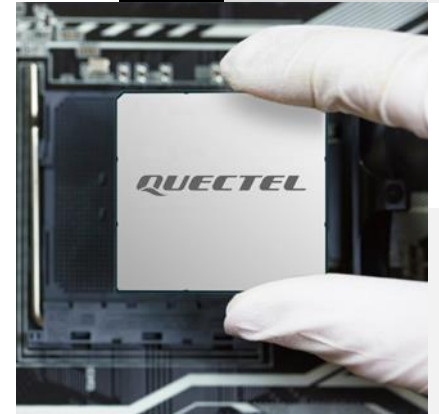

BG95-M1 Timeline (TX2.0, R04Axx with VoLTE)



2021									2022											
Apr.	May	Jun.	Jul.	Aug.	Sep.	Oct.	Nov.	Dec.	Jan.	Feb.	Mar.	Apr.	May	Jun.	Jul.	Aug.	Sep.	Oct.	Nov.	Dec.

Project Schedule

CS

MP

Version: BG95M1LAR04A01

- RF TX/ RX FTM
- PSM
- LTE RF Antenna Tuner
- DFOTA
- GNSS
- PPP/ TCP/ UDP/ IP
- FILE (UFS)
- SSL/ TLS
- Basic AT Commands
- QuecLocator®
- SMS
- PING
- NITZ
- FTP(S)/ HTTP(S)
- MQTT
- Handover
- IPv6
- Triangle Location
- NIDD
- CoAP
- VoLTE
- CMUX
- LwM2M
- Jamming Detection

Version: BG95M1LAR04Axx

- Fix bugs

Certification

Carrier	AT&T	-----	TBD
Regulatory	GCF/ PTCRB	-----	TBD

BG95-M1 Timeline (TX2.0, R05Axx Data Only)



2021									2022									
Apr.	May	Jun.	Jul.	Aug.	Sep.	Oct.	Nov.	Dec.	Jan.	Feb.	Mar.	Apr.	May	Jun.	Jul.	Aug.	Sep.	Oct.

Project Schedule

CS

MP

Version: BG95M1LAR05A01

- RF TX/ RX FTM
- PSM
- LTE RF Antenna Tuner
- DFOTA
- GNSS
- PPP/ TCP/ UDP/ IP
- FILE (UFS)
- SSL/ TLS
- Basic AT Commands
- QuecLocator®
- SMS
- PING
- NITZ
- FTP(S)/ HTTP(S)
- MQTT
- Handover
- IPv6
- Triangle Location
- NIDD
- CoAP
- CMUX
- LwM2M
- Jamming Detection
- QuecOpen®

Version: BG95M1LAR05Axx

- Fix bugs

Certification

Carrier	T-Mobile	-----	Completed
	AT&T	-----	Start (Planned) Complete (Planned)
	Verizon	-----	TBD
Regulatory	GCF/ PTCRB	-----	Completed

BG95-M2 Timeline (TX2.0, R04Axx with VoLTE)



2021									2022											
Apr.	May	Jun.	Jul.	Aug.	Sep.	Oct.	Nov.	Dec.	Jan.	Feb.	Mar.	Apr.	May	Jun.	Jul.	Aug.	Sep.	Oct.	Nov.	Dec.

Project Schedule

CS

MP

Version: BG95M2LAR04A01

- RF TX/ RX FTM
- PSM
- LTE RF Antenna Tuner
- DFOTA
- GNSS
- PPP/ TCP/ UDP/ IP
- FILE (UFS)
- SSL/ TLS
- Basic AT Commands
- QuecLocator®
- SMS
- PING
- NITZ
- FTP(S)/ HTTP(S)
- MQTT
- Handover
- IPv6
- Triangle Location
- NIDD
- CoAP
- VoLTE
- CMUX
- LwM2M
- Jamming Detection

Version: BG95M2LAR04Axx

- Fix bugs

Certification

Carrier	AT&T	-----	TBD
Regulatory	GCF/ PTCRB	-----	TBD

BG95-M2 Timeline (TX2.0, R05Axx Data Only)



2021									2022									
Apr.	May	Jun.	Jul.	Aug.	Sep.	Oct.	Nov.	Dec.	Jan.	Feb.	Mar.	Apr.	May	Jun.	Jul.	Aug.	Sep.	Oct.

Project Schedule

CS

MP

Version: BG95M2LAR05A01

- RF TX/ RX FTM
- PSM
- LTE RF Antenna Tuner
- DFOTA
- GNSS
- PPP/ TCP/ UDP/ IP
- FILE (UFS)
- SSL/ TLS
- Basic AT Commands
- QuecLocator®
- SMS
- PING
- NITZ
- FTP(S)/ HTTP(S)
- MQTT
- Handover
- IPv6
- Triangle Location
- NIDD
- CoAP
- CMUX
- LwM2M
- Jamming Detection
- QuecOpen®

Version: BG95M2LAR05Axx

- Fix bugs

Certification

Carrier	T-Mobile	-----	Completed
	AT&T	-----	Start Complete (Planned)
Regulatory	Verizon	-----	TBD
	GCF/ PTCRB	-----	Completed

BG95-M3 Timeline (TX2.0, R04Axx with VoLTE)



2021									2022									
Apr.	May	Jun.	Jul.	Aug.	Sep.	Oct.	Nov.	Dec.	Jan.	Feb.	Mar.	Apr.	May	Jun.	Jul.	Aug.	Sep.	Oct.

Project Schedule



Certification

Carrier	AT&T	-----	Completed
Regulatory	GCF/ PTCRB	-----	Completed

BG95-M3 Timeline (TX2.0, R05Axx Data Only)



2021									2022											
Apr.	May	Jun.	Jul.	Aug.	Sep.	Oct.	Nov.	Dec.	Jan.	Feb.	Mar.	Apr.	May	Jun.	Jul.	Aug.	Sep.	Oct.	Nov.	Dec.

Project Schedule

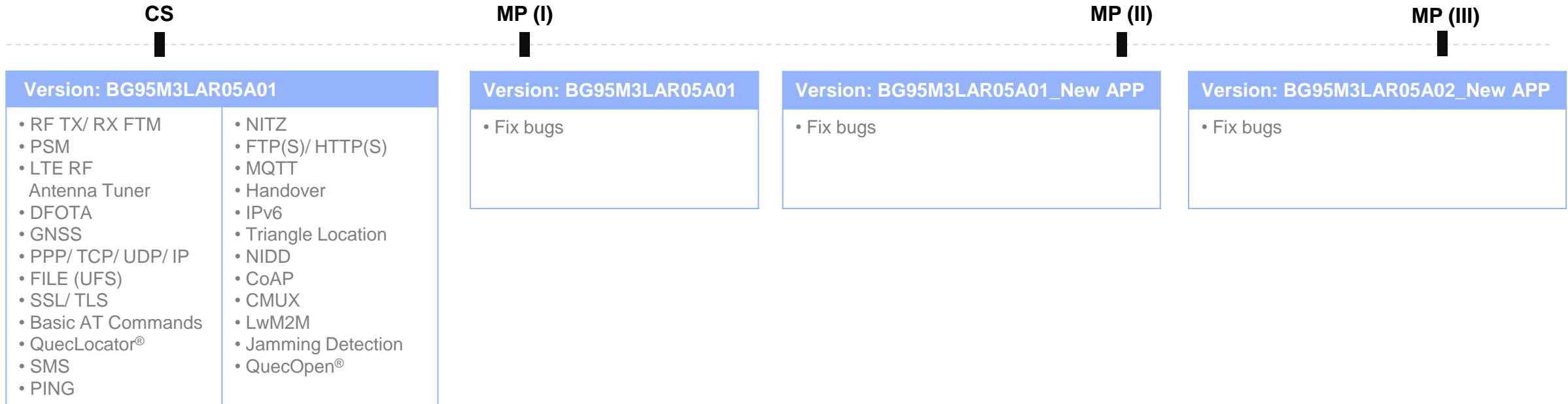

Certification



BG95-M4 Timeline (TX2.0, R05Axx Data Only)



2021									2022											
Apr.	May	Jun.	Jul.	Aug.	Sep.	Oct.	Nov.	Dec.	Jan.	Feb.	Mar.	Apr.	May	Jun.	Jul.	Aug.	Sep.	Oct.	Nov.	Dec.

Project Schedule

CS

MP

Version: BG95M4LAR05A01	
<ul style="list-style-type: none"> • RF TX/ RX FTM • PSM • DFOTA • GNSS • PPP/ TCP/ UDP/ IP • FILE (UFS) • SSL/ TLS • Basic AT Commands • QuecLocator® • SMS • PING 	<ul style="list-style-type: none"> • NITZ • FTP(S)/ HTTP(S) • MQTT • Handover • IPv6 • Triangle Location • NIDD • CoAP • CMUX • LwM2M • Jamming Detection • QuecOpen®

Version: BG95M4LAR05Axx
<ul style="list-style-type: none"> • Fix bugs

Certification

Regulatory CE ----- Completed

BG95-M5 Timeline (TX2.0, R05Axx Data Only)



2021									2022											
Apr.	May	Jun.	Jul.	Aug.	Sep.	Oct.	Nov.	Dec.	Jan.	Feb.	Mar.	Apr.	May	Jun.	Jul.	Aug.	Sep.	Oct.	Nov.	Dec.

Project Schedule

CS

MP

Version: BG95M5LAR05A01	
<ul style="list-style-type: none"> • RF TX/ RX FTM • PSM • LTE RF Antenna Tuner • DFOTA • GNSS • PPP/ TCP/ UDP/ IP • FILE (UFS) • SSL/ TLS • Basic AT Commands • QuecLocator® • SMS • PING 	<ul style="list-style-type: none"> • NITZ • FTP(S)/ HTTP(S) • MQTT • Handover • IPv6 • Triangle Location • NIDD • CoAP • CMUX • LwM2M • Jamming Detection • QuecOpen®

Version: BG95M5LAR05Axx
<ul style="list-style-type: none"> • Fix bugs

Certification

Carrier	Verizon/ AT&T	TBD
Regulatory	GCF/ PTCRB	TBD

BG95-M6 Timeline (TX2.0, R05Axx Data Only)



2021									2022											
Apr.	May	Jun.	Jul.	Aug.	Sep.	Oct.	Nov.	Dec.	Jan.	Feb.	Mar.	Apr.	May	Jun.	Jul.	Aug.	Sep.	Oct.	Nov.	Dec.

Project Schedule

CS

MP

Version: BG95M6LAR05A01	
<ul style="list-style-type: none"> • RF TX/ RX FTM • PSM • LTE RF Antenna Tuner • DFOTA • GNSS • PPP/ TCP/ UDP/ IP • FILE (UFS) • SSL/ TLS • Basic AT Commands • QuecLocator® • SMS • PING 	<ul style="list-style-type: none"> • NITZ • FTP(S)/ HTTP(S) • MQTT • Handover • IPv6 • Triangle Location • NIDD • CoAP • CMUX • LwM2M • Jamming Detection • QuecOpen®

Version: BG95M6LAR05Axx
<ul style="list-style-type: none"> • Fix bugs

Certification

Carrier	Verizon/ AT&T	TBD
Regulatory	GCF/ PTCRB	TBD

BG95-MF Timeline (TX2.0, R05Axx Data Only)



2021						2022											
Jul.	Aug.	Sep.	Oct.	Nov.	Dec.	Jan.	Feb.	Mar.	Apr.	May	Jun.	Jul.	Aug.	Sep.	Oct.	Nov.	Dec.

Project Schedule

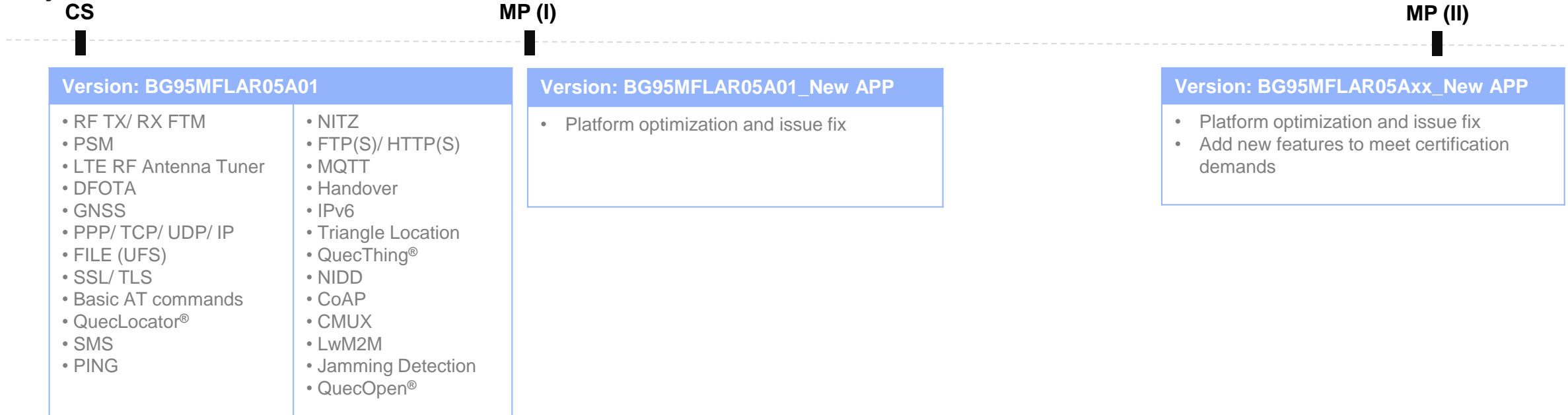

Certification

Carrier	Vodafone/ Deutsche Telekom	Completed
	Verizon/ AT&T	TBD
Regulatory	GCF/ CE/ PTCRB/ FCC/ IC/ RCM	Completed

BG95-M9 Timeline (TX2.0, R05Axx Data Only)



2022											
Jan.	Feb.	Mar.	Apr.	May	Jun.	Jul.	Aug.	Sep.	Oct.	Nov.	Dec.

Project Schedule



Certification

Regulatory	CE/ RCM	Completed
	Anatel	TBD

BG77 Timeline (TX2.0, R04Axx with VoLTE)



2021									2022											
Apr.	May	Jun.	Jul.	Aug.	Sep.	Oct.	Nov.	Dec.	Jan.	Feb.	Mar.	Apr.	May	Jun.	Jul.	Aug.	Sep.	Oct.	Nov.	Dec.

Project Schedule

CS

MP

Version: BG77LAR04A01	
<ul style="list-style-type: none"> • RF TX/RX FTM • PSM • LTE RF antenna tuner • DFOTA • GNSS • PPP/TCP/UDP/IP • FILE (UFS) • SSL/TLS • Basic AT commands • QuecLocator® • SMS • PING 	<ul style="list-style-type: none"> • NITZ • FTP(S)/HTTP(S) • MQTT • Handover • IPv6 • Triangle Location • NIDD • CoAP • VOLTE • CMUX • LwM2M • Jamming Detection

Version: BG77LAR04A01_New App
<ul style="list-style-type: none"> • Fix bugs

BG77 Timeline (TX2.0, R05Axx Data Only)



2021									2022											
Apr.	May	Jun.	Jul.	Aug.	Sep.	Oct.	Nov.	Dec.	Jan.	Feb.	Mar.	Apr.	May	Jun.	Jul.	Aug.	Sep.	Oct.	Nov.	Dec.

Project Schedule

CS

MP

Version: BG77LAR05A01

<ul style="list-style-type: none"> • RF TX/ RX FTM • PSM • LTE RF Antenna Tuner • DFOTA • GNSS • PPP/ TCP/ UDP/ IP • FILE (UFS) • SSL/ TLS • Basic AT Commands • QuecLocator® • SMS • PING 	<ul style="list-style-type: none"> • NITZ • FTP(S)/ HTTP(S) • MQTT • Handover • IPv6 • Triangle Location • NIDD • CoAP • CMUX • LwM2M • Jamming Detection • QuecOpen®
--	---

Version: BG77LAR05A01_New APP

- Fix bugs

Certification

Carrier	T-Mobile	Completed
	AT&T	
	Verizon	TBD
Regulatory	PTCRB	Completed

BG600L-M3 Timeline (TX2.0, R04Axx with VoLTE)



2021									2022								
Apr.	May	Jun.	Jul.	Aug.	Sep.	Oct.	Nov.	Dec.	Jan.	Feb.	Mar.	Apr.	May	Jun.	Jul.	Aug.	Sep.

Project Schedule

CS

MP (I)

MP (II)

Version: BG600LM3LAR04A01	
<ul style="list-style-type: none"> • RF TX/ RX FTM • PSM • LTE RF Antenna Tuner • DFOTA • GNSS • PPP/ TCP/ UDP/ IP • FILE (UFS) • SSL/ TLS • Basic AT Commands • QuecLocator® • SMS • PING 	<ul style="list-style-type: none"> • NITZ • FTP(S)/HTTP(S) • MQTT • Handover • IPv6 • Triangle Location • NIDD • CoAP • VOLTE • CMUX • LwM2M • Jamming Detection

Version: BG600LM3LAR04A01_New App
<ul style="list-style-type: none"> • Fix bugs

Version: BG600LM3LAR04A01_New App
<ul style="list-style-type: none"> • Fix bugs

BG600L-M3 Timeline (TX2.0, R05Axx Data Only)



2021									2022								
Apr.	May	Jun.	Jul.	Aug.	Sep.	Oct.	Nov.	Dec.	Jan.	Feb.	Mar.	Apr.	May	Jun.	Jul.	Aug.	Sep.

Project Schedule

CS

MP

Version: BG600LM3LAR05A01

<ul style="list-style-type: none"> • RF TX/ RX FTM • PSM • LTE RF Antenna Tuner • DFOTA • GNSS • PPP/ TCP/ UDP/ IP • FILE (UFS) • SSL/ TLS • Basic AT Commands • QuecLocator® • SMS • PING 	<ul style="list-style-type: none"> • NITZ • FTP(S)/ HTTP(S) • MQTT • Handover • IPv6 • Triangle Location • NIDD • CoAP • CMUX • LwM2M • Jamming Detection • QuecOpen®
--	---

Version: BG600LM3LAR05A01

- Fix bugs

Certification

Carrier	T-Mobile	Completed
	AT&T	Start Complete (Planned)
Regulatory	GCF/ PTCRB	Completed



Technical Background
LPWA Roadmap
Highlights & Specifications
Development Timeline

Technical Details

Applications
Appendix

Build a Smarter World

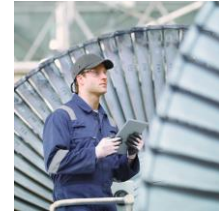
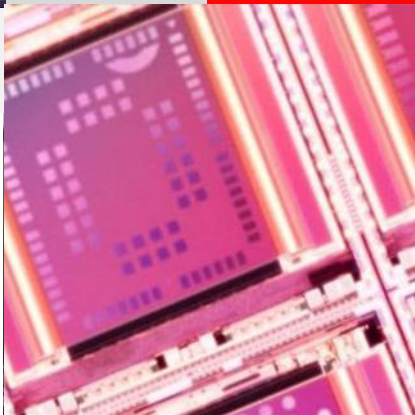
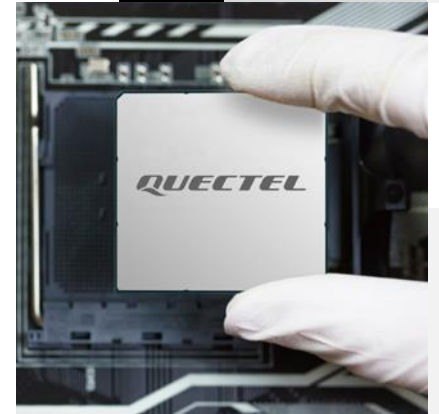

Hardware Architecture

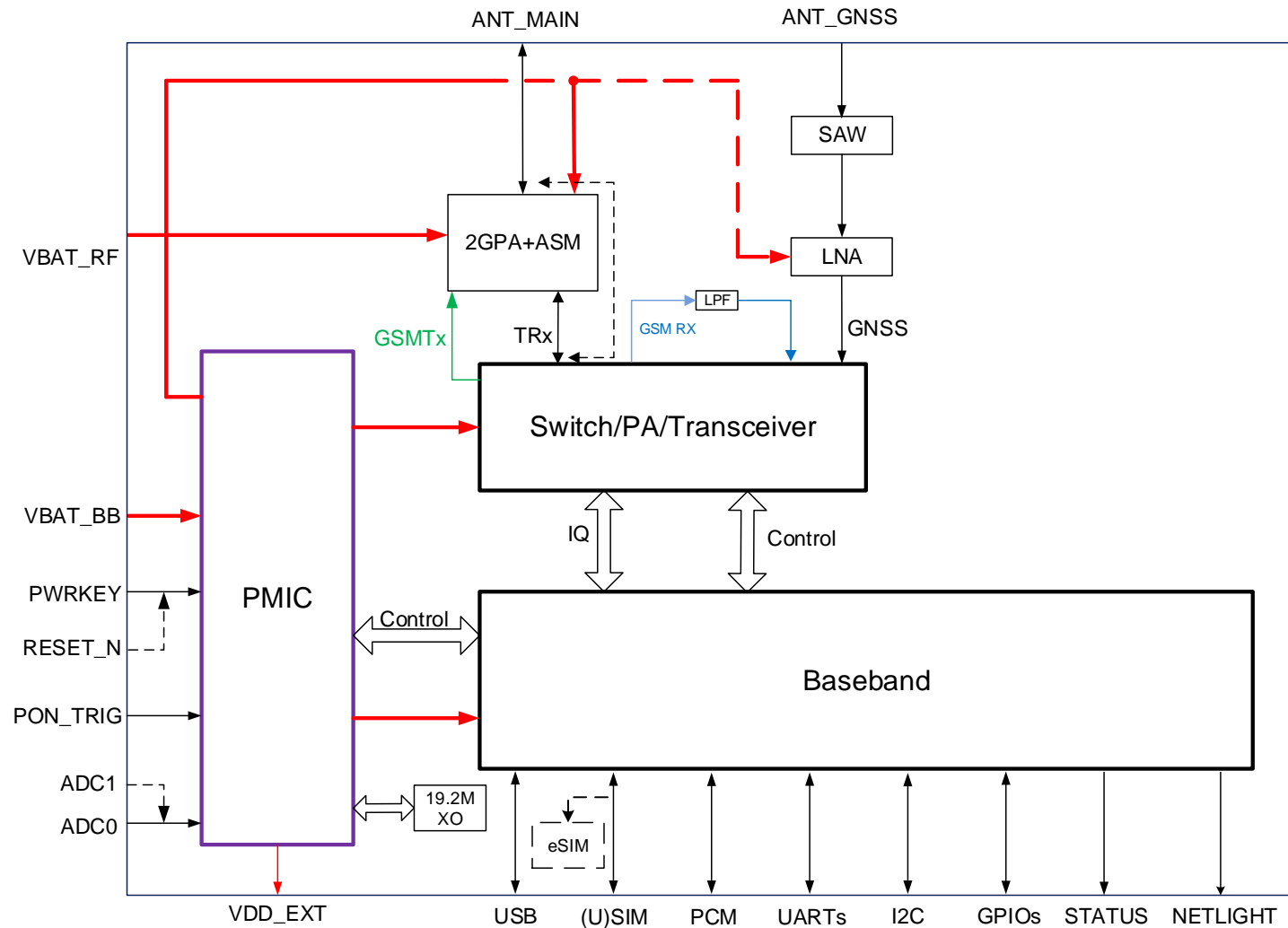

Take BG95-M3 as an example.

Key Technologies 1 - PSM

Power Saving Mode (PSM) is similar to power-off, but the module remains registered on the network. When the module is woken up from PSM, there is no need to re-attach or re-establish PDN connection. When the module in PSM, it is not immediately reachable for mobile terminating services. PSM is therefore intended for applications that are expecting only infrequent mobile originating and terminating services and that can accept a corresponding latency in the mobile terminating communication.

When the module wants to use the PSM it shall request an Active Time value during every Attach and TAU/RAU procedures. If the network supports PSM and accepts that the module uses PSM, the network confirms usage of PSM by allocating an Active Time value to the module.

The following figure illustrates the power consumption cycle of the module.

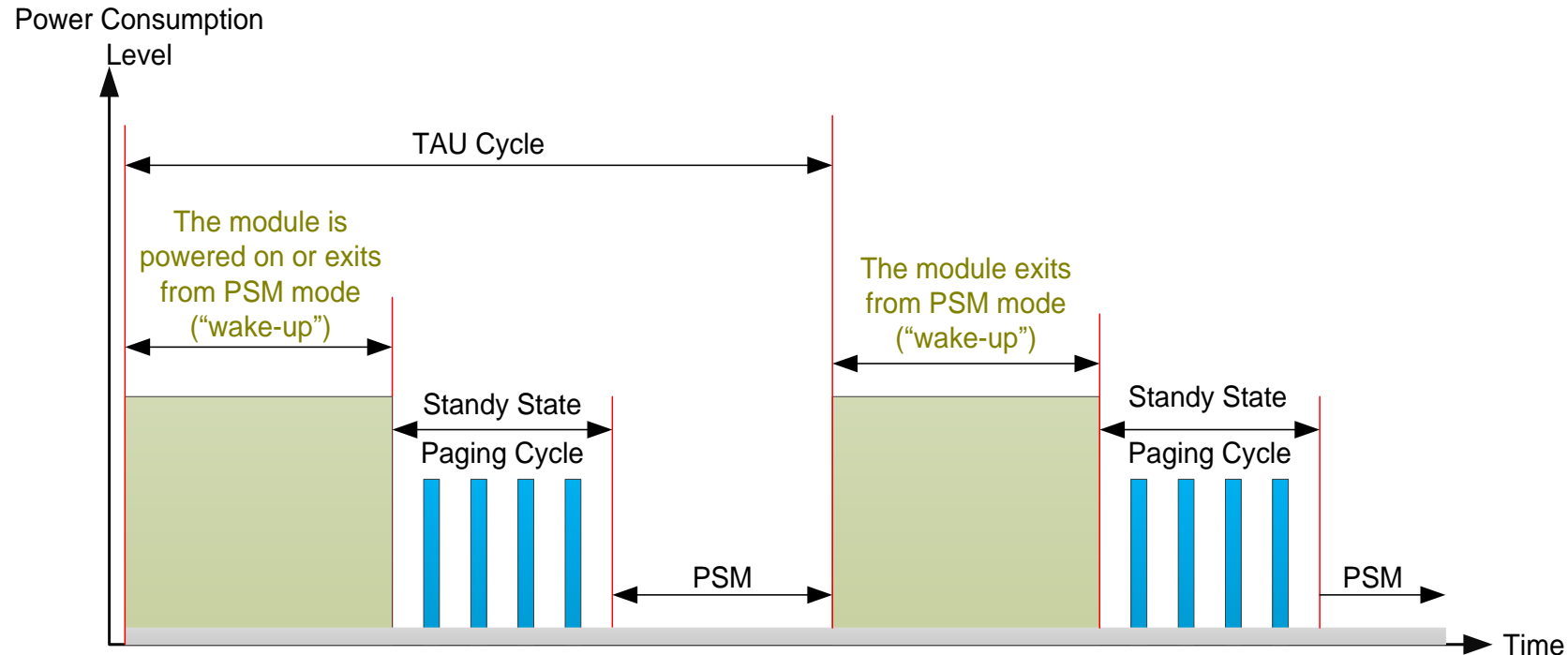

Key Technologies 2 - e-I-DRX

The module (UE) and the network may negotiate over non-access stratum signaling the use of Extended Idle Mode DRX (e-I-DRX) for reducing its power consumption, while being available for mobile terminating data and/or network originated procedures within a certain delay dependent on the DRX cycle value.

Applications that want to use e-I-DRX need to consider specific handling of mobile terminating services or data transfers, and in particular they need to consider the delay tolerance of mobile terminated data.

The following figure illustrates the DRX and e-I-DRX cycle of the module.

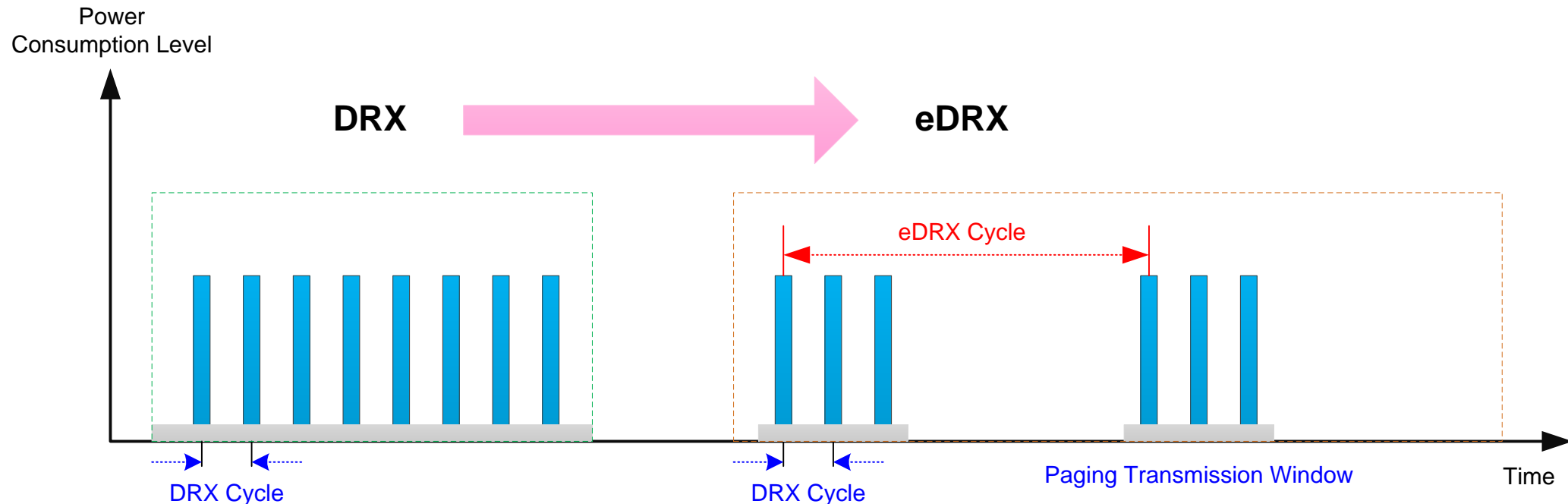

Support Package

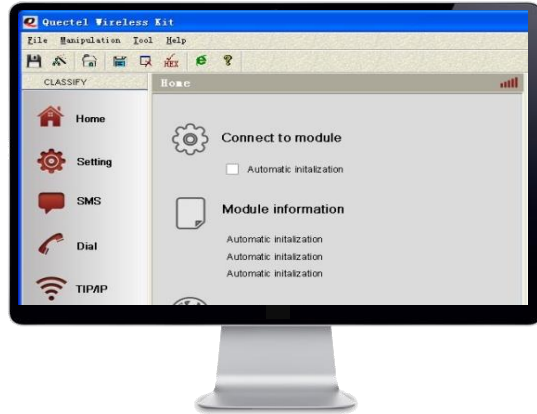

Quectel provides a graphical user interface (GUI) tool QNavigator, which can help customers quickly test the functions of Quectel modules.

EVB Kit



BG95 Series/ BG77/ BG600L-M3

TE-B



BG95 Series/ BG77/ BG600L-M3



Technical Background
LPWA Roadmap
Highlights & Specifications
Development Timeline
Technical Details
Applications
Appendix

Build a Smarter World

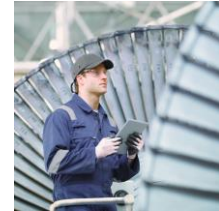
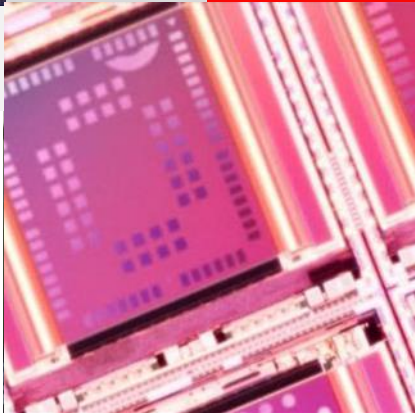
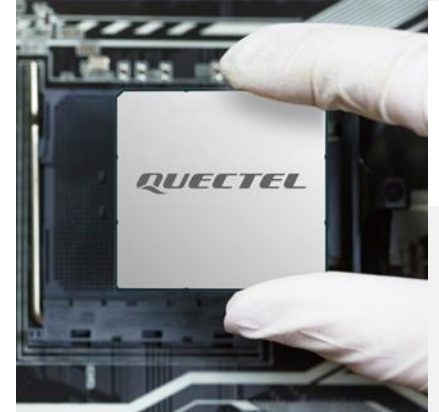

LPWA Application Scenarios



Public Utilities

- Water/ Gas Metering
- Smart Parking
- Fire Hydrant
- Smoke Detector
- Street Lighting
- Smart Dustbin

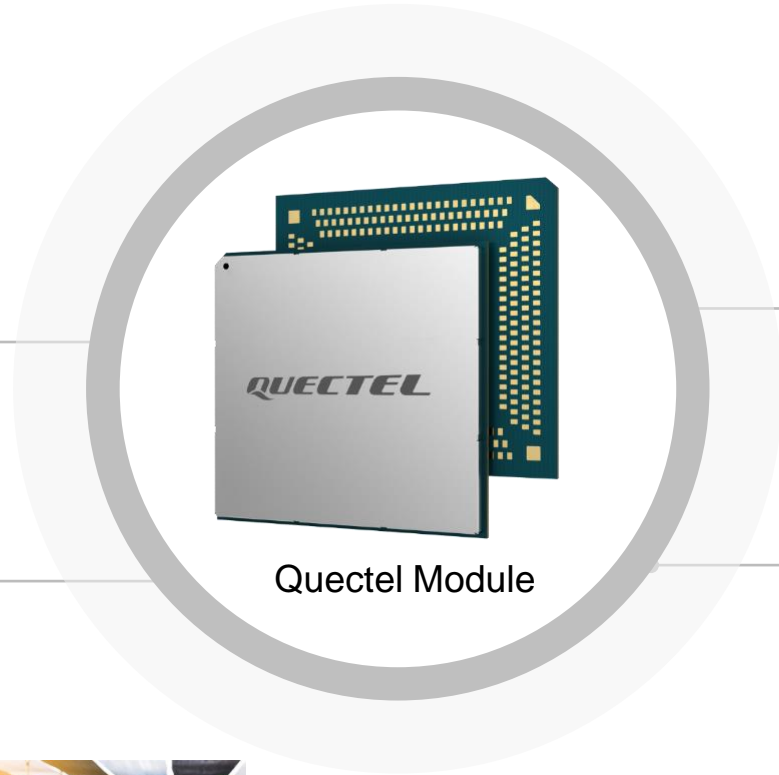

Smart Life

- Asset Tracking
- Wearable Devices
- Person/ Pet Tracking



Industry & Agriculture

- Gas Detector
- Soil PH/ Optical Sensor
- Machine Alarm
- Irrigation Controller



Smart Home

- Intelligent Door Lock
- Intelligent Control



PH: Potential of hydrogen.

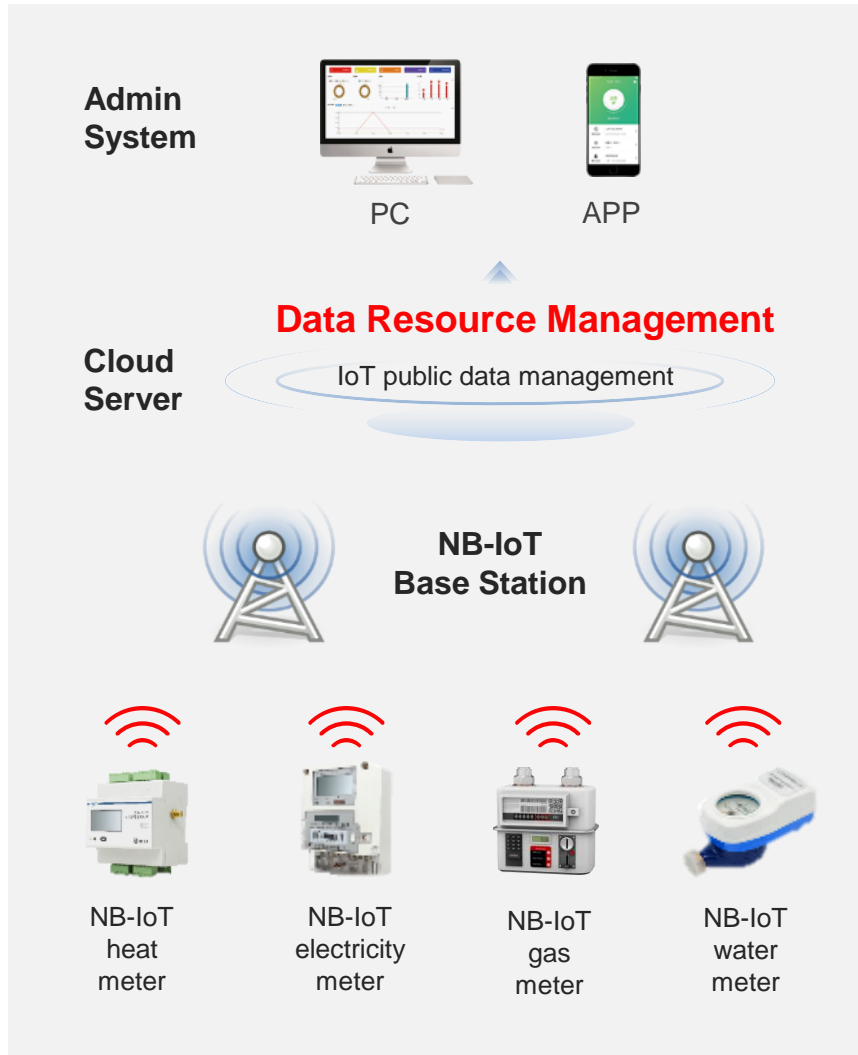

Remote Meter Reading



- Solve the problems of low efficiency and high cost caused by manual reading
- Real-time information of power/ water/ gas consumption

Data Analysis



- Automatically generate statistical report
- Provide accurate calculation of production and sales difference
- Regional consumption statistics
- Annual, monthly and daily consumption statistics

Energy Conservation



- Report abnormal dosage immediately
- Save energy

Stable and Reliable Data Transmission



- Establish information management system
- Improve energy consumption management
- Meet the requirements of certain data encryption

Smart City – Street Lighting

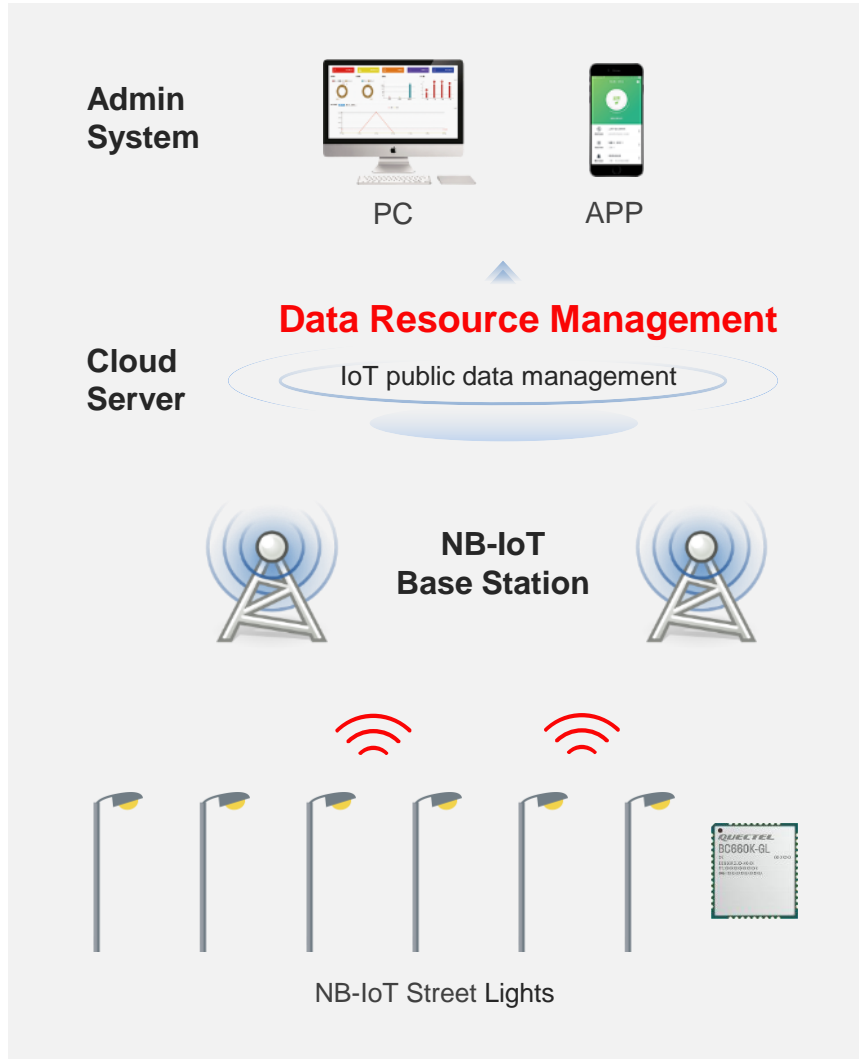

Remote Control



- Solve the problems of low efficiency and high cost caused by manual control
- Real-time information of power consumption and brightness
- Adjust brightness of street lights

Data Analysis



- Automatically generate statistical report
- Real-time data feeds directly to the operation center
- Annual, monthly and daily consumption statistics
- Report abnormal lamp immediately

Energy Conservation



- Control street lights on both sides of the road to be turned on or off, or control street lights on either side of the road to be turned on with different time periods
- Save energy

Stable and Reliable Data Transmission



- Establish information management system
- Improve energy consumption management
- Reduce maintenance costs via NB network

Smart Tracker



OBD Tracking



Scooter Tracking

Cat M Module

- Acquire positioning data
- Communication with center server
- Device management system
- Electronic fence



Logistic Tracking



Person/ Pet Tracking

OBD: On Board Diagnostics

Smart Home

Feature: Non-inductive connection, automation, machine learning

Trend: Smarter, more convenient, safer, more energy-efficient

Including: White goods, black goods, security, monitors, medical treatment, healthcare, wearables, wireless controllers, etc.

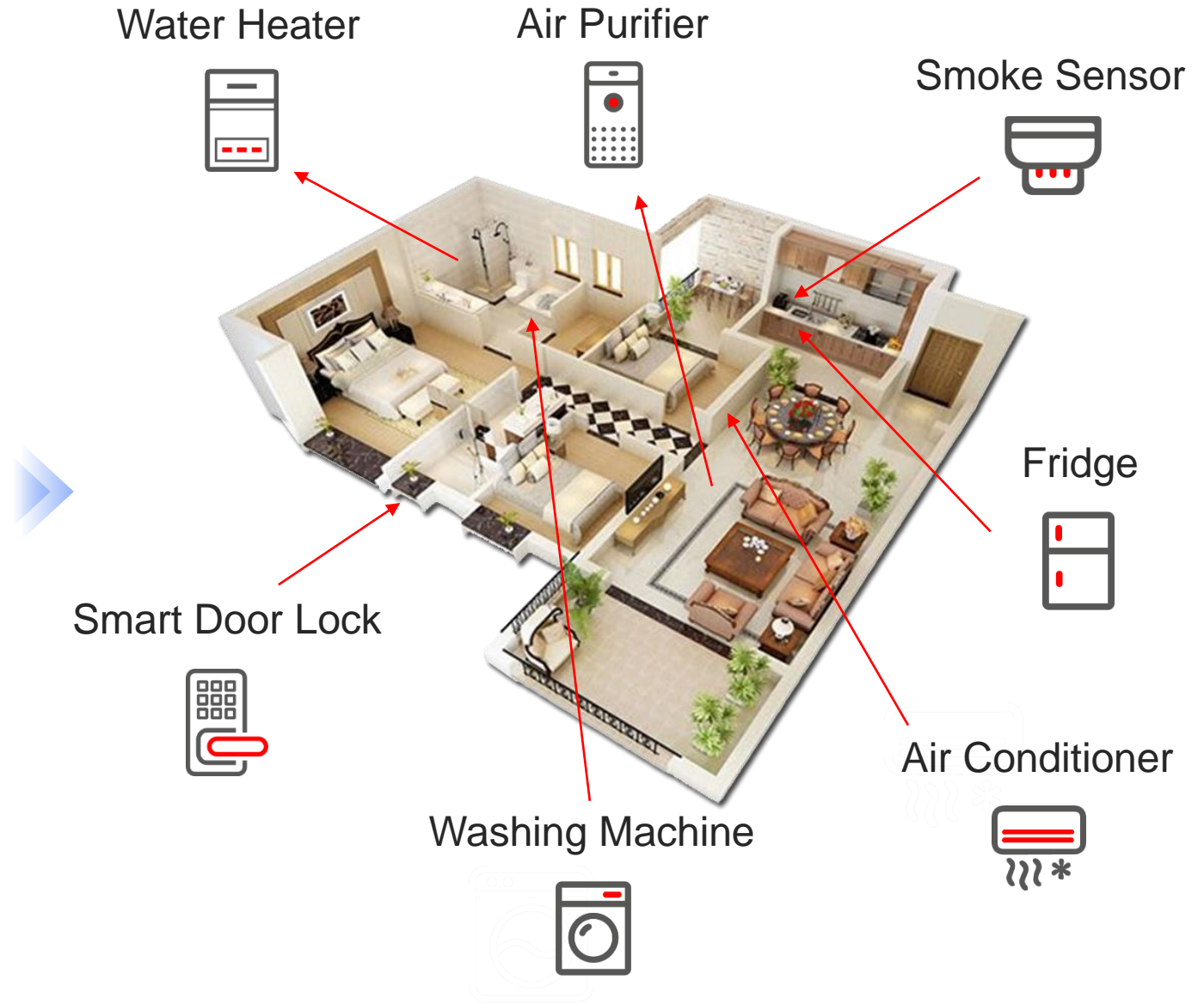

Smart Sensor Detector

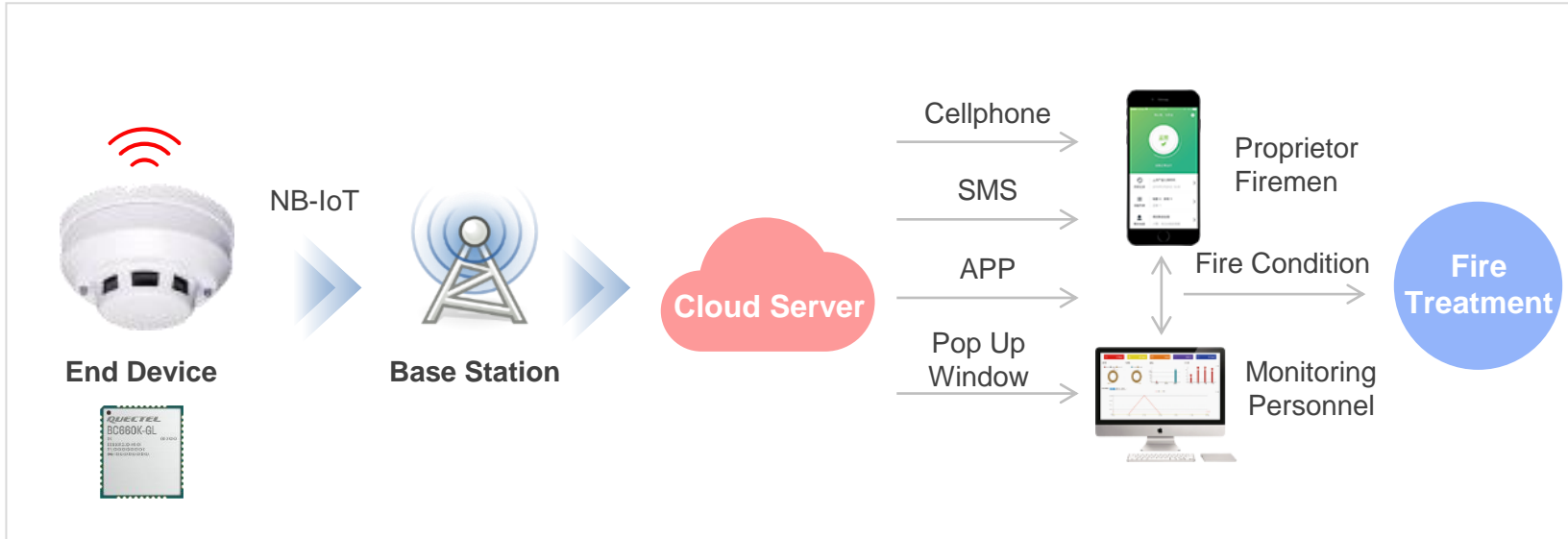

Features

- Long battery life
- Extended communication distance
- Battery-under-voltage reminder function
- Anti-disassembly, anti-theft and timely reminder functions
- The wireless communication adopts NB-IoT technology with strong transmission capability
- Hazardous gas monitoring, including VOCs, combustibles and toxics, etc.



Easy Connection to Sensors

Provide abundant hardware interfaces to connect to peripheral sensors



Quick Response

Audible and visual alarms, and remote alarms (notified through SMS, WeChat, telephone, etc.)



Easy Installation and Remote Maintenance

Wireless issue diagnosis implementation without physical damage



Public Cellular Network

No need for Wi-Fi configuration

SMS: Short message service
VOC: Volatile organic compound



Technical Background
LPWA Roadmap
Highlights & Specifications
Development Timeline
Technical Details
Applications

Appendix

Build a Smarter World

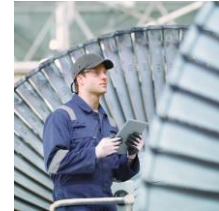
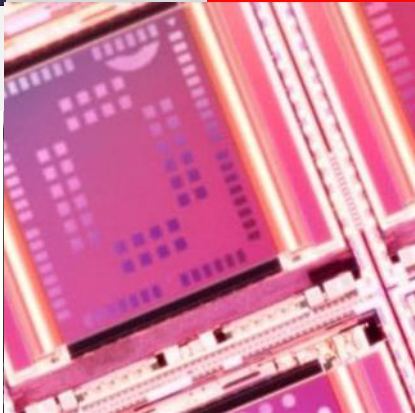
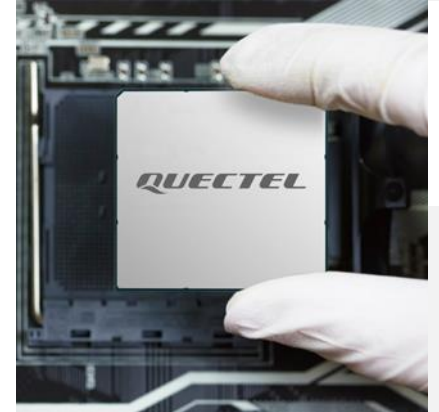

Appendix – NB Deployment (1/2)



NB = 121								
Country/ Region	Operator	Bands	Country/ Region	Operator	Bands	Country/ Region	Operator	Bands
Argentina	Claro	4, 28	China	China Telecom	5	France	SFR	20
Argentina	MNO Personal	28	China	China Unicom	3, 8	Germany	Telefónica	8, 20
Argentina	Movistar	4, 28	China(Hong Kong)	3	8	Germany	Vodafone	20
Australia	Telstra	28	China(Hong Kong)	China Mobile	3	Germany	Deutsche Telekom	8, 20
Australia	Vodafone	8	China(Hong Kong)	SmarTone	8	Greece	Vodafone	20
Australia	Optus	28	China(Taiwan)	APTG	8	Greece	T-Mobile (Cosmote)	20
Austria	A1	20	China(Taiwan)	Chunghwa	8	Hungary	T-Mobile	20
Austria	T-Mobile (Magenta)	8	China(Taiwan)	FarEasTone	28	Hungary	Vodafone	20
Bangladesh	Grameenphone	3, 8 (TBC)	China(Taiwan)	Taiwan Mobile	28	India	Reliance Jio	3, 5
Belarus	A1	/	Colombia	Claro	5	Indonesia	Telkomsel	8
Belarus	Velcom	8	Colombia	Movistar	5	Indonesia	XL Axiata	8
Belgium	BASE (Telenet)	3, 20	Croatia	A1	20	Ireland	Vodafone	20
Belgium	Proximus	20	Croatia	T-Mobile (DT)	8, 20	Italy	Vodafone	20
Belgium	Orange	3,20	Czech	Vodafone	8, 20	Italy	Telecom Italia/ TIM	20
Brazil	Claro	3, 28	Denmark	Telenor	20	Japan	SoftBank	1, 8
Brazil	Vivo	3, 28	Denmark	Telia	20, 8	Kazakstan	KCELL	/
Brazil	Telecom Italia/ TIM	28	Denmark	TDC	20	Kenya	SafariCom	8
Canada	Rogers	4, 5, 12	Estonia	Telia	20	Latvia	Bite	20
Chile	Claro	28	Estonia	Elisa	20	Latvia	LMT	20
Chile	Movistar	28	Finland	Telia	20	Latvia	Tele2	20
Chile	Entel	28	Finland	DNA	20, 3	Lithuania	Bite	28
China	China Mobile	8	Finland	Elisa	20, 3	Lithuania	Telia	28

[Back](#)

Appendix – NB Deployment (2/2)



NB = 121								
Country/ Region	Operator	Bands	Country/ Region	Operator	Bands	Country/ Region	Operator	Bands
Lithuania	Tele2	28	Saudi Arabia	STC	12	Turkey	Turkcell	1, 8, 20
Malaysia (6 Cities)	Maxis	3	Serbia	Vip Mobile (A1)	20, 8	Turkey	Vodafone	8, 20
Malta	Vodafone	/	Singapore	M1	8	UAE	DU	20
Mexico	ALTAN	28	Singapore	StarHub	3, 8	UAE	Etisalat	20
Mexico	AT&T	5	Singapore	Singtel	8	Ukraine	Kyivstar	3
Mexico	Telcel	5	Slovakia	T-Mobile (Slovakia Telecom)	20	Ukraine	Vodafone	3
Netherlands	T-Mobile (DT)	20	Slovenia	A1	20	United Kingdom	Vodafone	20
Netherlands	Vodafone	20	Slovenia	Telekom Slovenije	20	Uruguay	Antel	3,28
New Zealand	Vodafone	28	South Africa	Vodafone	8	USA	AT&T	2, 4, 12
Norway	Telenor	8, 20	South Africa	Vodacom	3, 8, 28	USA	T-Mobile	2, 4, 12, 66, 71, 85
Norway	Telia	20	South Korea	KT	3	USA	Verizon	13
Peru	Claro	28	South Korea	LGU+	5	New Zealand	Spark	28
Peru	Movistar	28	Spain	Telefónica	20			
Poland	T-Mobile (DT)	20	Spain	Vodafone	8, 20			
Portugal	Altice	20	Spain	Orange	20			
Portugal	Vodafone	8, 20	Sri Lanka	Dialog Axiata	3, 8			
Portugal	NOS	3,20	Sri Lanka	Mobitel	3,8			
Romania	Vodafone	20	Sweden	Telia	20			
Russia	MegaFon	20, 8, 3	Switzerland	Swisscom	20			
Russia	MTS	3	Thailand	AIS	8			
Saudi Arabia	Zain	3	Thailand	TRUE	8			
Saudi Arabia	Mobily	20	Thailand	DTAC	28			

[Back](#)

Appendix – Cat M Deployment



Cat M = 63								
Country/ Region	Operator	Bands	Country/ Region	Operator	Bands	Country/ Region	Operator	Bands
Argentina	Claro	28	Germany	Deutsche Telekom	8, 20	Singapore	SingTel	3, 8
Argentina	MNO Personal	28	Germany	Telefónica	20	South Korea	KT	3
Argentina	Movistar	4,28	Hungary	MVM Group	31	South Korea	LGU+	5
Argentina	Personal	4,28	Japan	KDDI	18, 26	South Korea	SKT	3, 5
Australia	Telstra	28	Japan	NTT DOCOMO	1, 19	Spain	Orange	3, 20
Belgium	Orange	20	Japan	SoftBank	1, 3, 8	Spain	Telefonia	20
Brazil	Claro	3, 28	Latvia	LMT	20	Sri Lanka	Dialog Axiata	8
Brazil	Vivo	3,28	Mexico	ALTAN	28	Sweden	Telenor	20
Canada	Bell	12	Mexico	América Móvil	4	Sweden	Telia	20
Canada	Rogers	4, 5, 12	Mexico	AT&T	4	Switzerland	Swisscom	20
Canada	Telus	2, 4, 5, 12	Mexico	Movistar	2	Thailand	AIS	3, 8
Chile	Claro	28	Mexico	Telcel	4	Turkey	Turkcell	20
China(Taiwan)	APTG	8	Netherlands	KPN	20	UAE	Etisalat	5
China(Taiwan)	Chunghwa	3	Netherlands	T-Mobile (DT)	8	UK	O2 Telefonica	20
Colombia	Claro	5	Netherlands	Vodafone	20	Uruguay	Antel	3, 28
Colombia	Movistar	4	New Zealand	Spark	3, 28	US	USCC	2, 4, 5, 12
Colombia	Telefonica	2	New Zealand	Vodafone	3, 8, 28	USA	AT&T	2, 4, 12
Denmark	Telenor	20	Norway	Telenor	20	USA	Verizon	4, 13
Estonia	Elisa	/	Peru	Claro	28	USA	Sprint	25
Finland	DNA	20, 3	Peru	Entel	2, 28			
France	Bouygues Telecom	20	Peru	Movistar	4			
France	Orange	20, 3	Romania	Orange	3			

[Back](#)



We are a global IoT solutions provider, backed by outstanding support and services, to deliver a smarter world.

- Unbeatable choice from the broadest module portfolio in the world
- High quality range of off-the-shelf and customized antennas
- Providing Connectivity-as-a-Service
- Superb support with the largest R&D team in the industry
- Continuous innovation – in 5G, LPWA, CV2X, Smart Modules
- A passionate, dedicated team of “Quectelers” ensure our customers always come first

Thank You

Build a Smarter World

Building 5, Shanghai Business Park Phase III (Area B), No.1016 Tianlin Road, Minhang District, Shanghai 200233, China

Tel: **+86 21 5108 6236** Sales Support: sales@quectel.com

Technical Support: support@quectel.com General: info@quectel.com